

1 2 3 4 5 6 7 8

payload on 2 supports (symmetric)

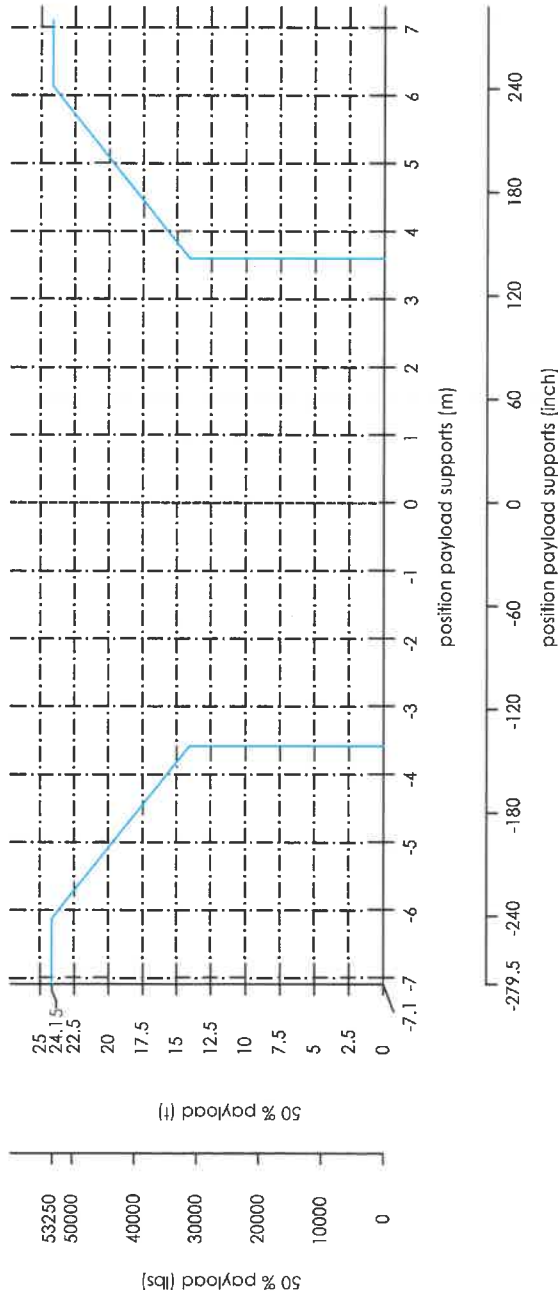

C.O.G.

(max. theoretical payload: 104500 lbs)

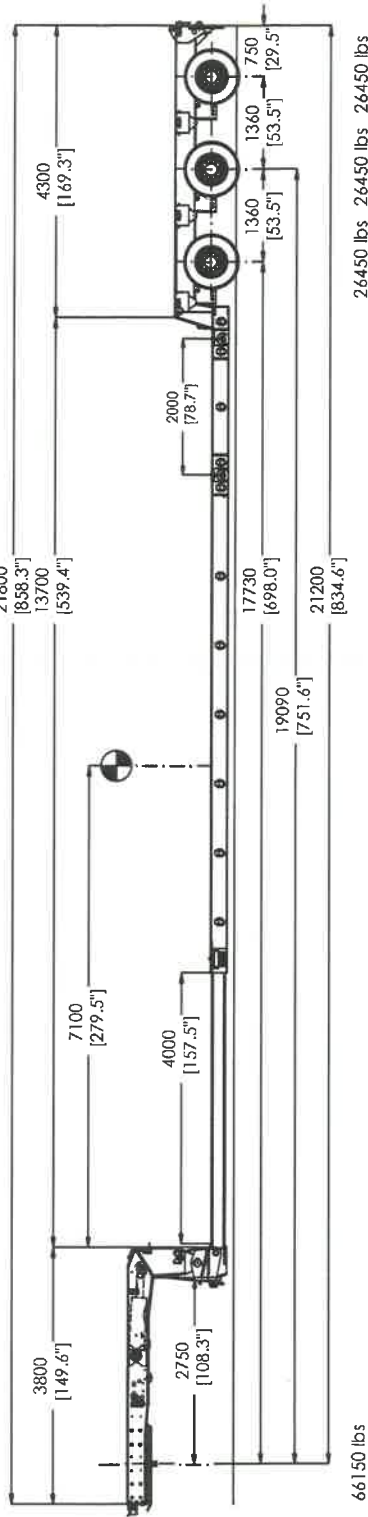

Zeichnung: WWP\_TBF-009650(41) Rev.: 1:75 A3

Datum	Name
04.02.19	BSC
gez.	
gepr.	

**Load Chart**  
 Mega-Z-3(3+1) L-V-KBX-A-30AT-7.70-17.5-2.54-US  
 Faymonville Distribution AG  
 Duarelsiroos 8  
 L-9990 Weiswampach  
 Tel.: +352 / 26 90 04 155  
 Fax.: +352 / 26 90 04 425  
 E-Mail : general@faymonville.com  
 Web : www.faymonville.com



Caution : the load chart does not take the deflection of the lowbed into account. The deflection of the lowbed has a direct impact on the ground clearance and on the axle compensation.

payload on 2 supports (symmetric)

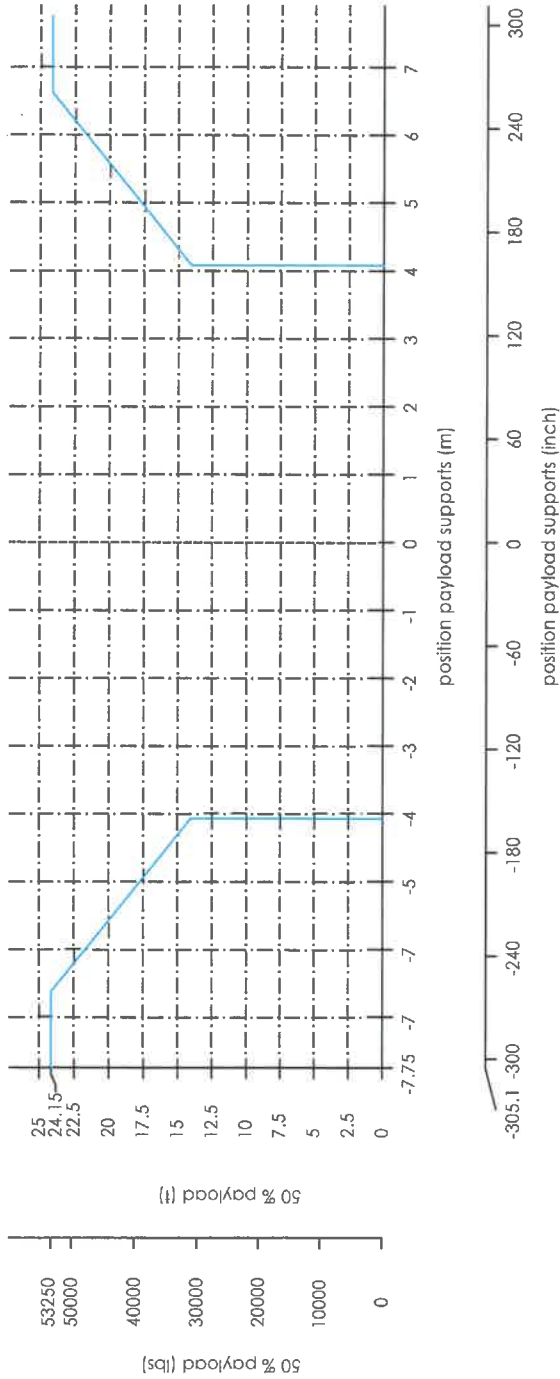

C.O.G.

(max. theoretical payload: 106500 lbs)

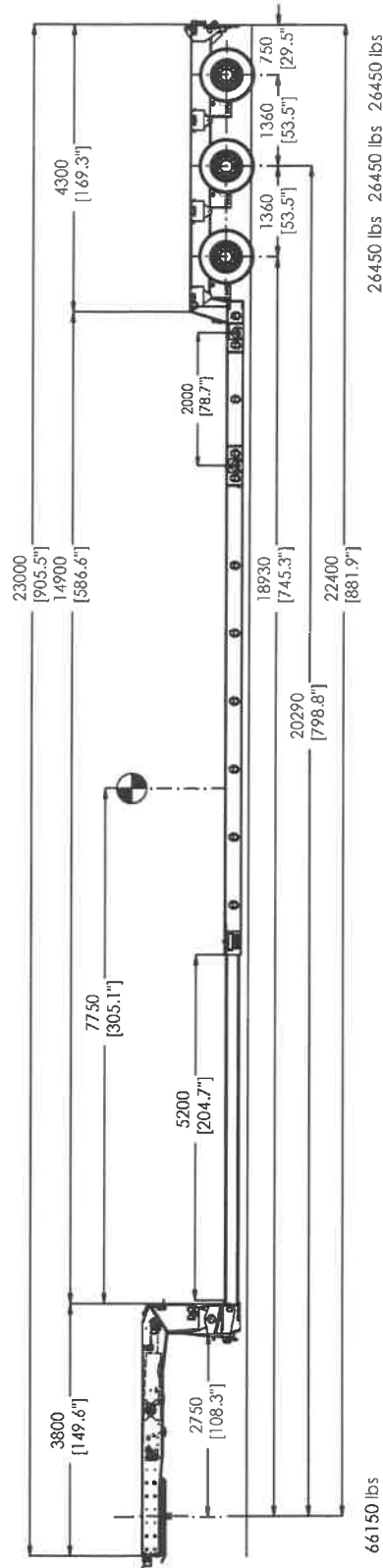

Zeichnung : WWP\_TBF-009650(42) Rev.:1

Datum	Name	1:75	A3
04.02.19	BSC		
gepr.			

**Load Chart**  
 Mega-Z-3(3+1) L-V-KBX-A-30A1-7.70-17.5-2.54-US  
 Faymonville Distribution AG  
 Duarretstroos 8  
 L-9990 Weiswampach  
 Tel.: +352 / 26 90 04 155  
 Fax: +352 / 26 90 04 425  
 E-Mail : general@faymonville.com  
 Web : www.faymonville.com



Caution : the load chart does not take the deflection of the lowbed into account. The deflection of the lowbed has a direct impact on the ground clearance and on the axle compensation.

payload on 2 supports (symmetric)

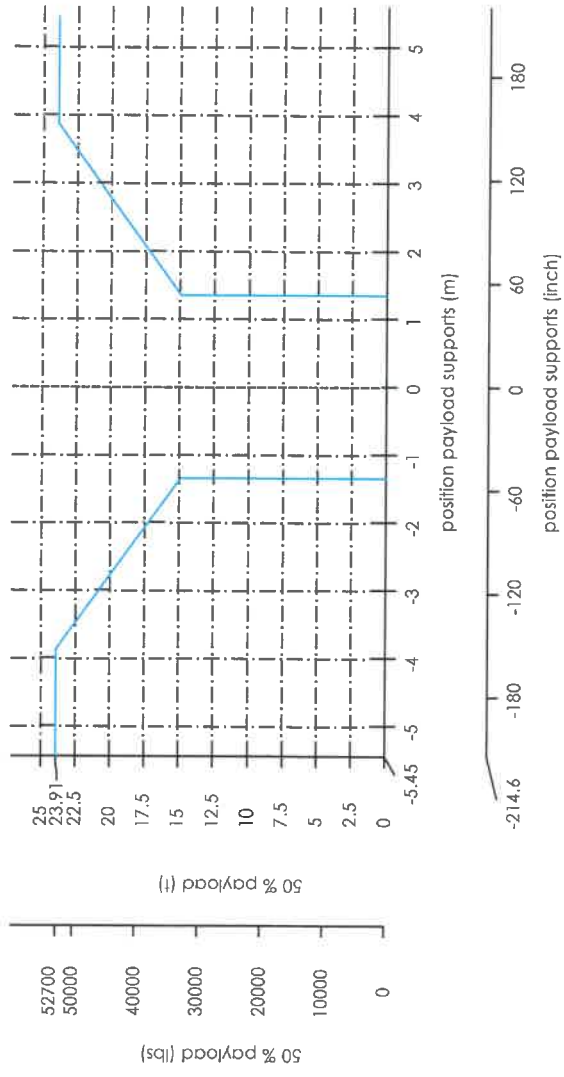

C.O.G.

(max. theoretical payload: 105400 lbs)

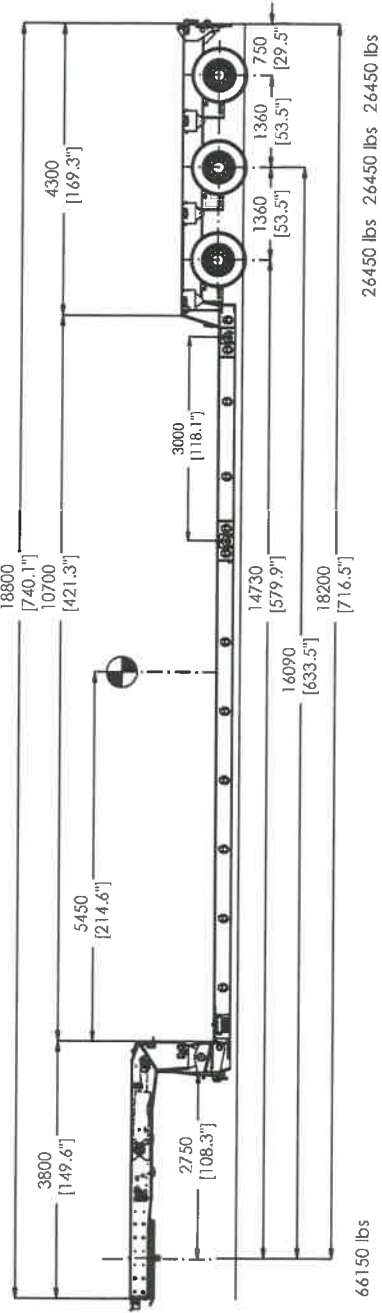

Zeichnung: WWP\_TBF-009650(43) Rev.:1

Datum	Name	1:75	A3
04.02.19	BSC		
gez.			
gepr.			

Load Chart

Mega-Z(3+1)-V-KBX-A-30AT-7.70-17.5-2.54-[US]

Faymonville Distribution AG  
 Duarrestroos 8  
 L-9990 Weiswampach  
 Tel.: +352 / 26 90 04 155  
 Fax.: +352 / 26 90 04 425  
 E-Mail : general@faymonville.com  
 Web : www.faymonville.com



Caution : the load chart does not take the deflection of the lowbed into account. The deflection of the lowbed has a direct impact on the ground clearance and on the axle compensation.

1 2 3 4 5 6 7 8

payload on 2 supports (symmetric)

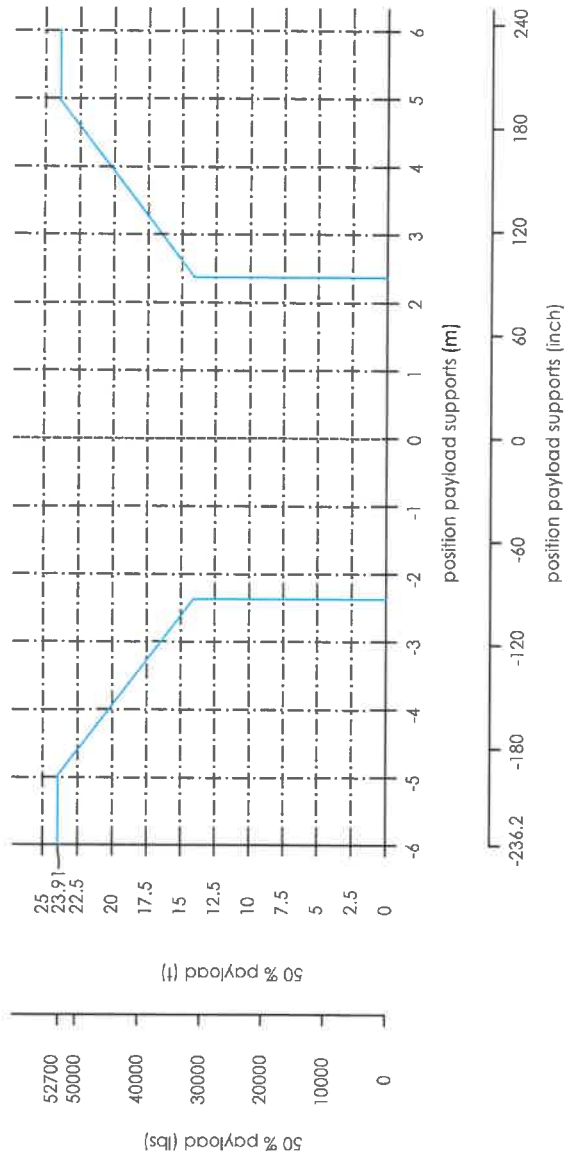

C.O.G.

(max. theoretical payload: 105400 lbs)

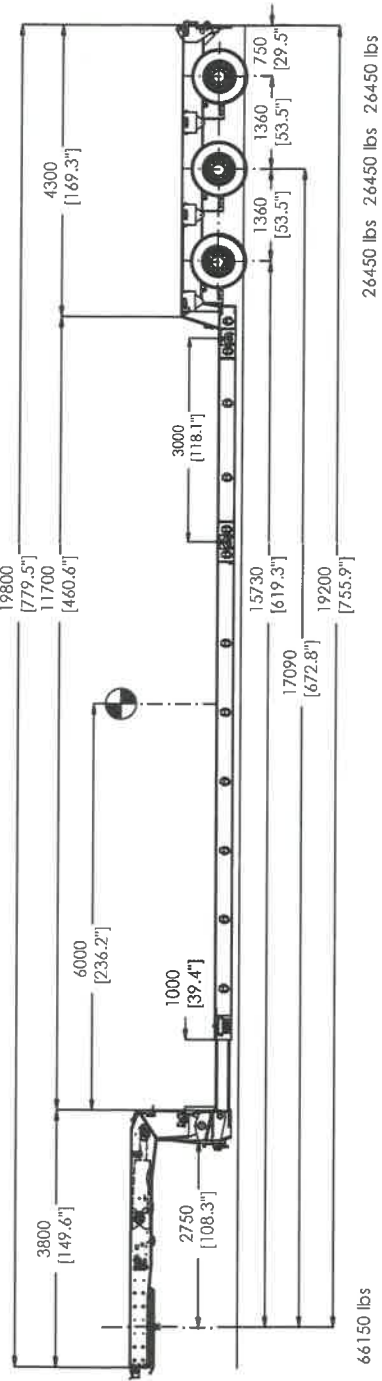

Zeichnung: WWP\_TBF-009650(44) Rev.:1

gez.	Datum	Name	1/75	A3
gspi.	04.02.19	BSC		

Load Chart

Mega-Z-3(3+1))L-V-KBX-A-30AT-7.70-17.5-2.54-(US)

Faymonville Distribution AG  
 Duarretstroos 8  
 L-9990 Weiswampach  
 Tel.: +352 / 26 90 04 155  
 Fax.: +352 / 26 90 04 425  
 E-Mail : general@faymonville.com  
 Web : www.faymonville.com



Caution : the load chart does not take the deflection of the lowbed into account. The deflection of the lowbed has a direct impact on the ground clearance and on the axle compensation.

1 2 3 4 5 6 7 8

payload on 2 supports (symmetric)

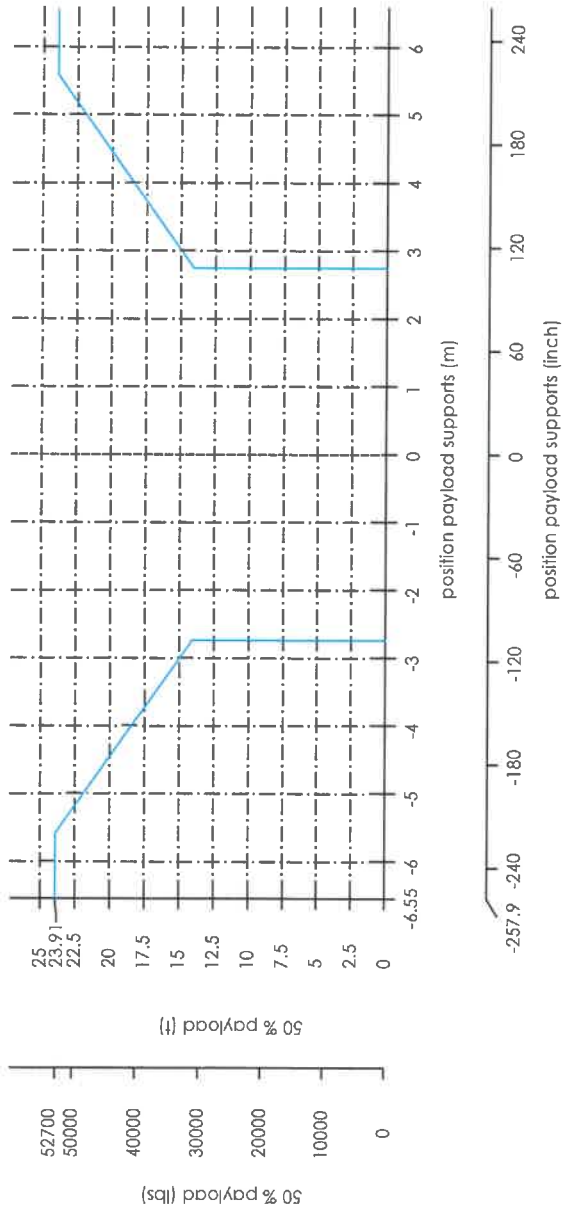

C.O.G.

(max. theoretical payload: 105400 lbs)

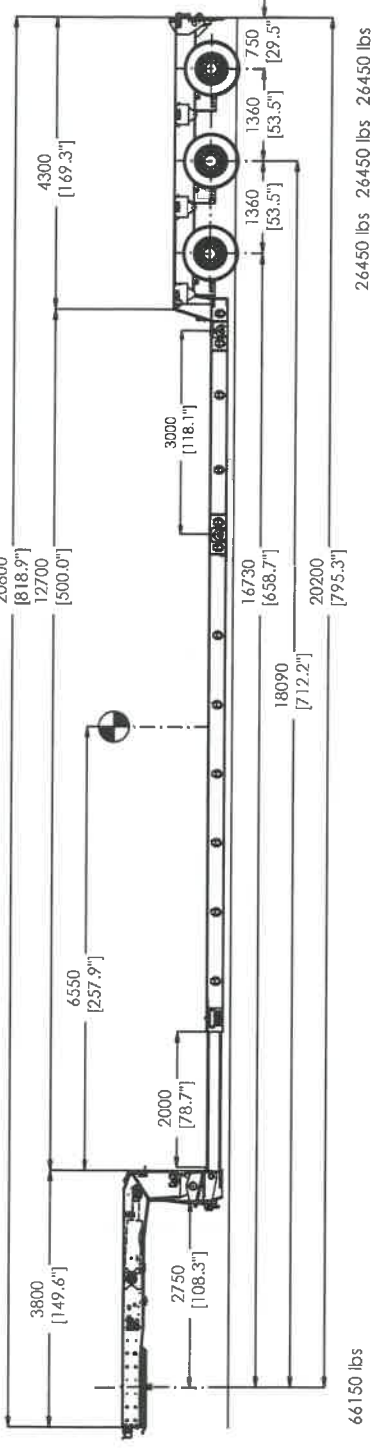

Zeichnung: WWP_TBF-009650(45)		Rev.: 1	
Datum	Name	1:75	A3
gez. 04.02.19	BSC		
gepr.			

**Load Chart**  
 Mega-Z-3(+1))L-V-KBX-A-30AT-7.70-17.5-2.54-[US]  
 Faymonville Distribution AG  
 Duarrefstroos 8  
 L-9990 Weiswampach  
 Tel.: +352 / 26 90 04 155  
 Fax.: +352 / 26 90 04 425  
 E-Mail : general@faymonville.com  
 Web : www.faymonville.com



Caution : the load chart does not take the deflection of the lowbed into account. The deflection of the lowbed has a direct impact on the ground clearance and on the axle compensation.

1 2 3 4 5 6 7 8

payload on 2 supports (symmetric)

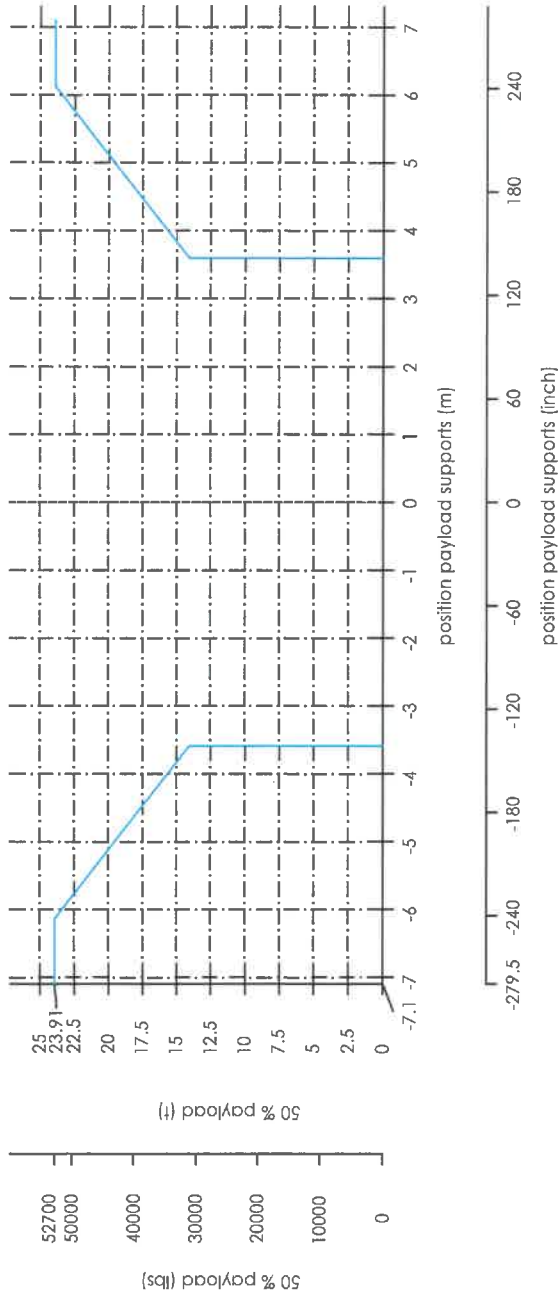

C.O.G.

(max. theoretical payload: 105400 lbs)

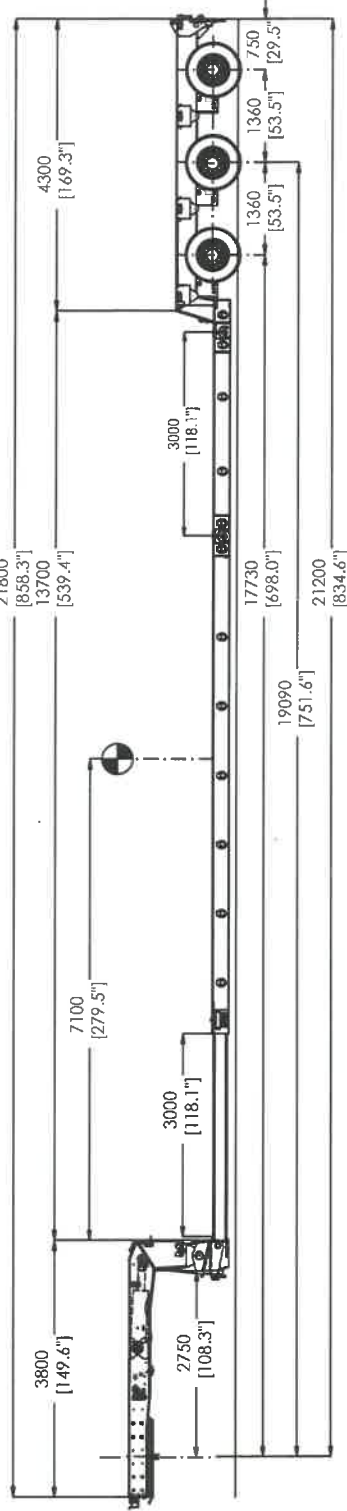

Zeichnung: WWP\_TBF-009650(46) Rev.: 1

Datum	Name	1/75	A3
gez. 04.02.19	BSC		
gepr.			

**Load Chart**  
 Mega-Z-3(3+1) L-V-KBX-A-30A1-7.70-17.5-2.54-US

Faymonville Distribution AG  
 Duarretroos 8  
 L-9990 Weiswampoch  
 Tel.: +352 / 26 90 04 155  
 Fax.: +352 / 26 90 04 425  
 E-Mail: general@faymonville.com  
 Web: www.faymonville.com



Caution : the load chart does not take the deflection of the lowbed into account. The deflection of the lowbed has a direct impact on the ground clearance and on the axle compensation.

payload on 2 supports (symmetric)

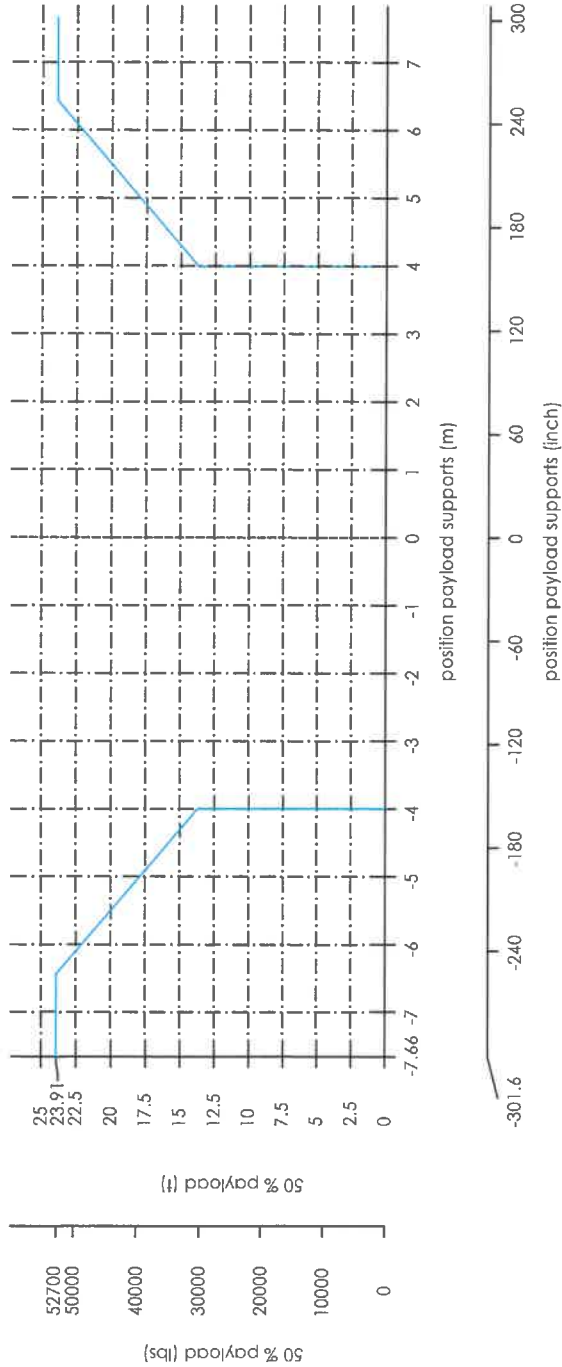

C.O.G.

(max. theoretical payload: 105400 lbs)

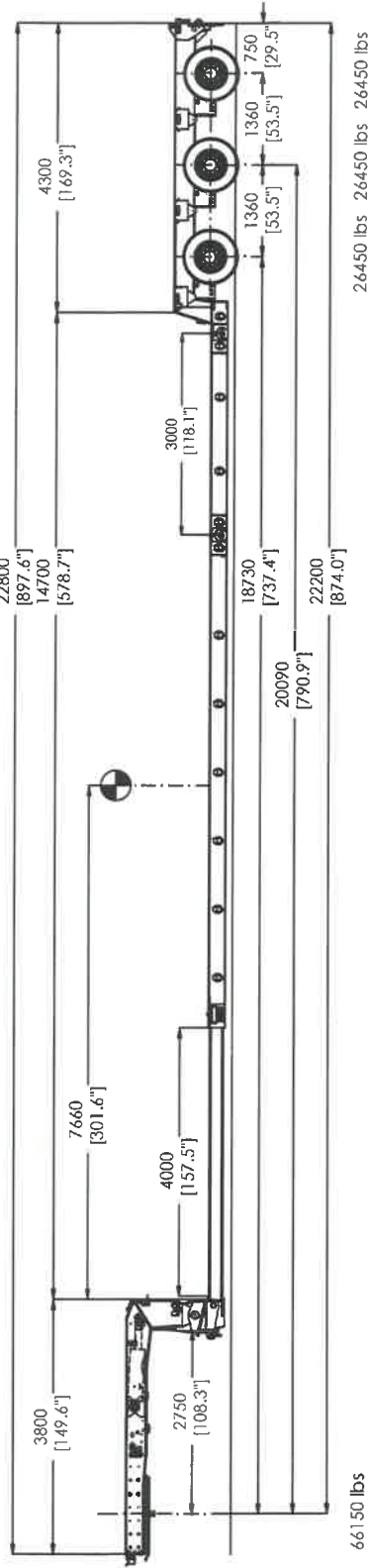

Zeichnung: WWP\_TBIF-009.650(47)

Rev.: 1

Datum	Name	1:75	A3
04.02.19	BSC		
gez.			
gepr.			

Load Chart

Mega-Z-3(3+1) L-V-KBX-A-30AT-7.70-17.5-2.54-US

Faymonville Distribution AG  
 Ducarrefstrass 8  
 L-9990 Weiswampach  
 Tel.: +352 / 26 90 04 155  
 Fax: +352 / 26 90 04 425  
 E-Mail: general@faymonville.com  
 Web: www.faymonville.com



Caution : the load chart does not take the deflection of the lowbed into account. The deflection of the lowbed has a direct impact on the ground clearance and on the axle compensation.

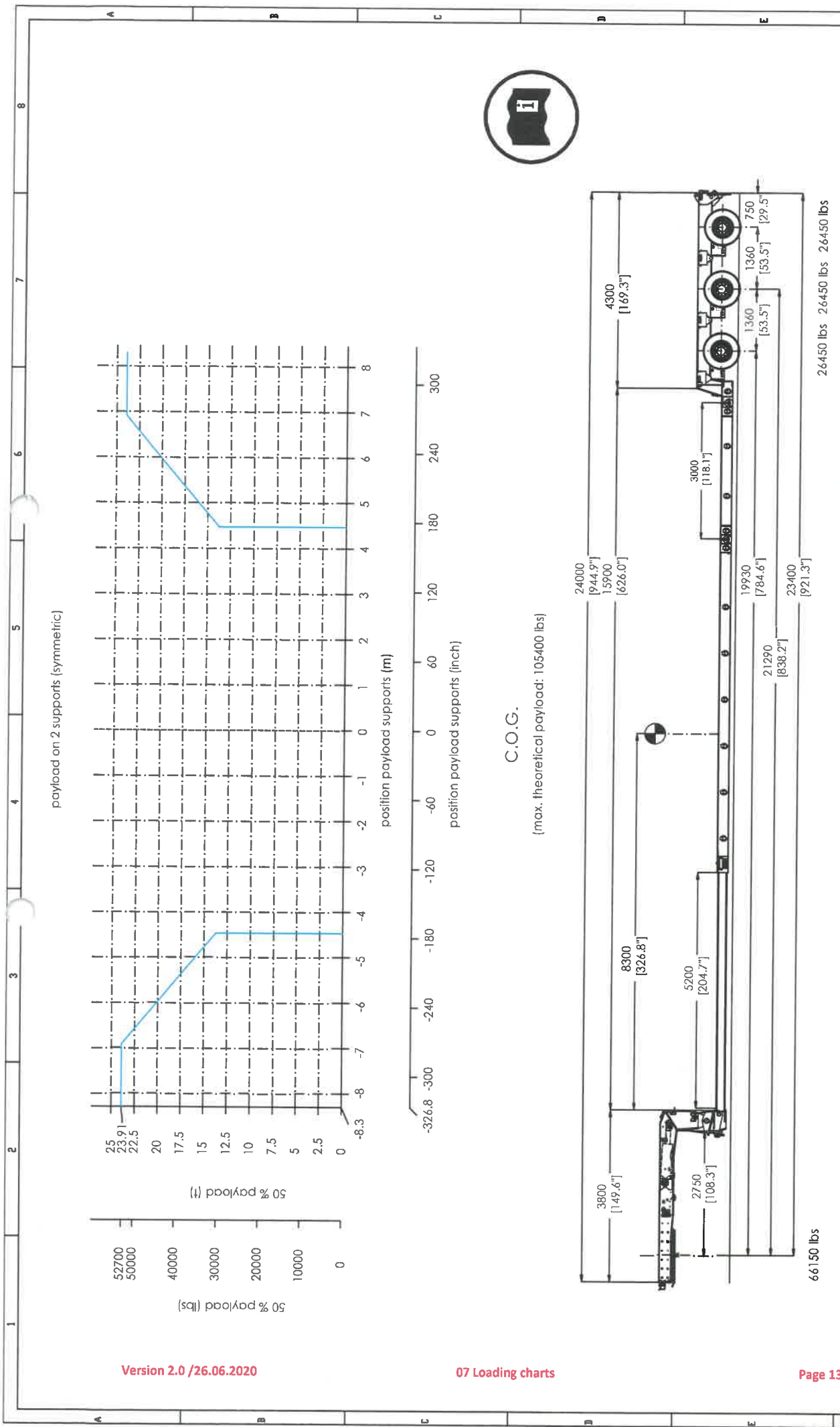

payload on 2 supports (symmetric)

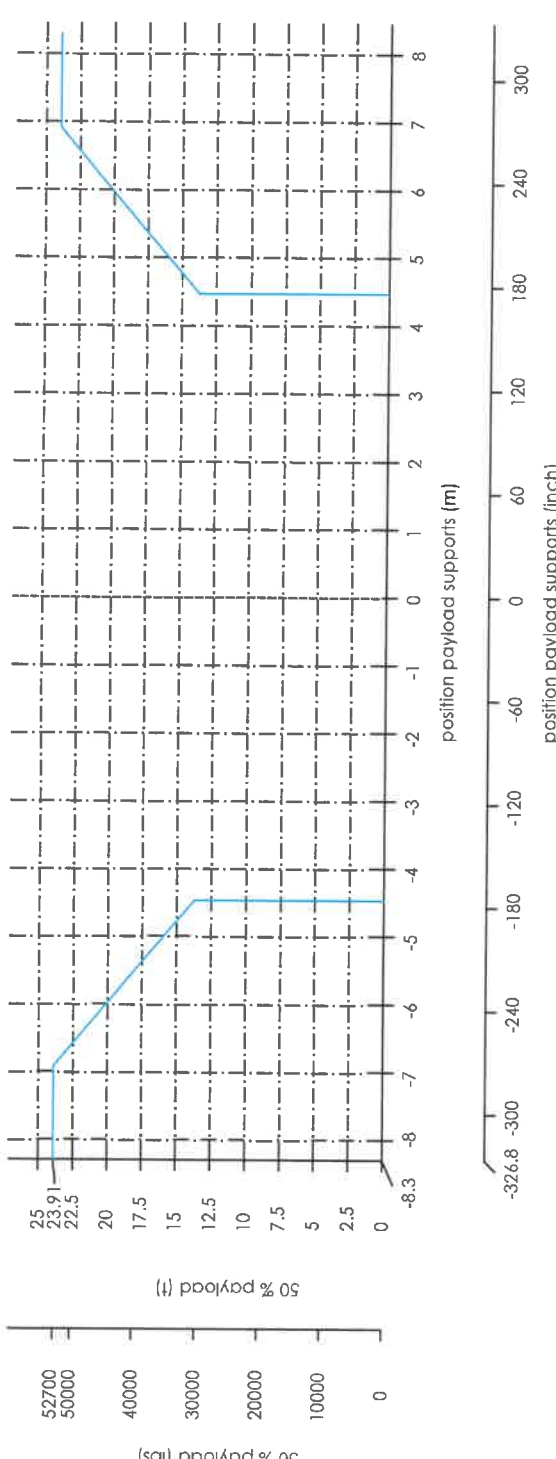

C.O.G.

(max. theoretical payload: 105400 lbs)

Zeichnung: WWP_TBF-009650(48)		Rev.: 1	
Datum	Name	1:75	A3
gez. 04.02.19	BSC		
gepr.			

**Load Chart**  
 Mega-Z-3(3+1)|L-V-KBX-A-30AT-7.70-17.5-2.54-(US)  
 Faymonville Distribution AG  
 Duarrefstroos 8  
 L-9990 Weiswampach  
 Tel.: +352 / 26 90 04 155  
 Fax.: +352 / 26 90 04 425  
 E-Mail: general@faymonville.com  
 Web: www.faymonville.com

Caution: the load chart does not take the deflection of the lowbed into account. The deflection of the lowbed has a direct impact on the ground clearance and on the axle compensation.





1 2 3 4 5 6 7 8

payload on 2 supports (symmetric)

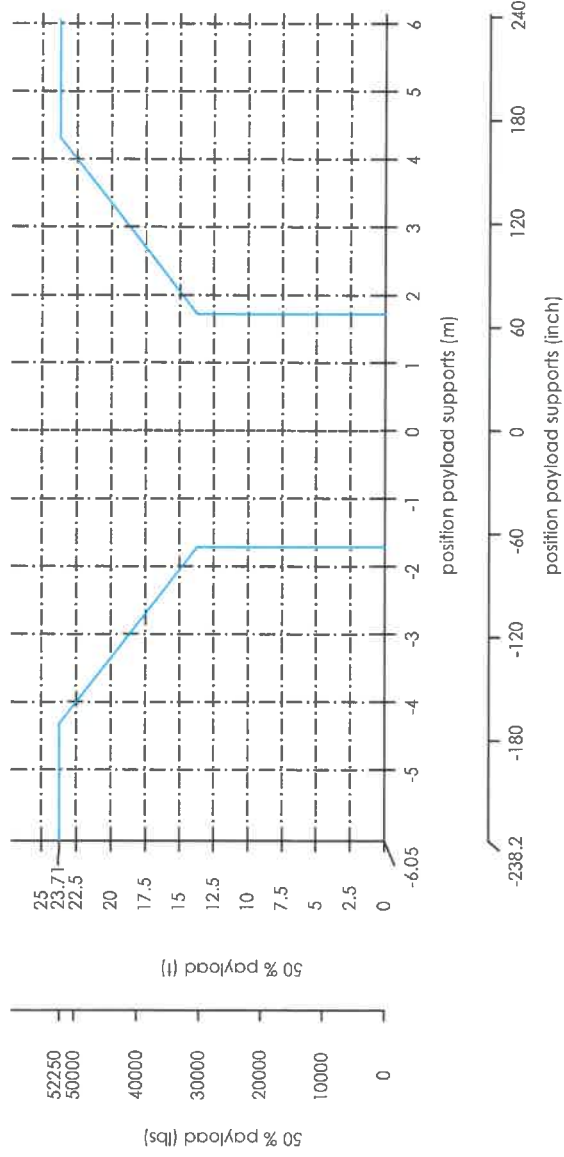

C.O.G.

(max. theoretical payload: 104500 lbs)

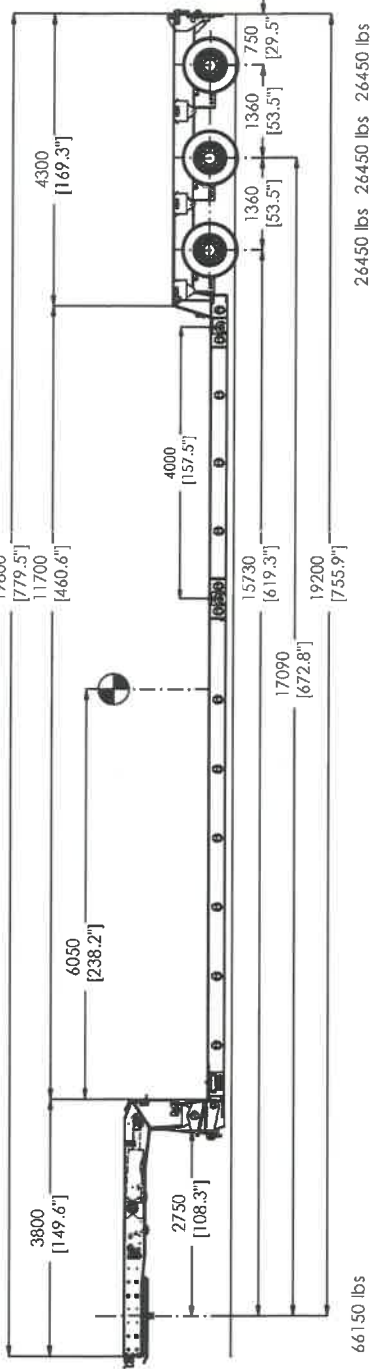

Zeichnung : WWP\_TBIF-009650(49) Rev.: 1

Datum	Name	1:75	A3
04.02.19	BSC		
gepr.			

**Load Chart**  
 Mega-L-3(3+1) L-V-KBX-A-30AT-7.70-17.5-2.54-(US)

Faymonville Distribution AG  
 Duarretstroos 8  
 L-9990 Weiswampach  
 Tel.: +352 / 26 90 04 155  
 Fax.: +352 / 26 90 04 425  
 E-Mail : general@faymonville.com  
 Web : www.faymonville.com



Caution : the load chart does not take the deflection of the lowbed into account. The deflection of the lowbed has a direct impact on the ground clearance and on the axle compensation.

payload on 2 supports (symmetric)

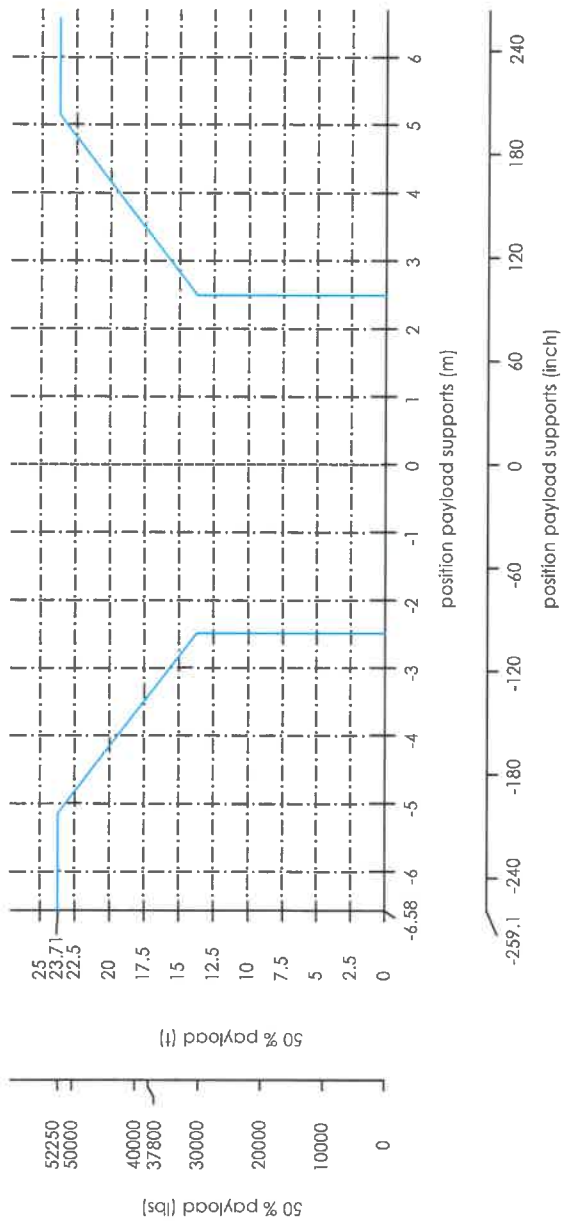

C.O.G.

(max. theoretical payload: 14500 lbs)

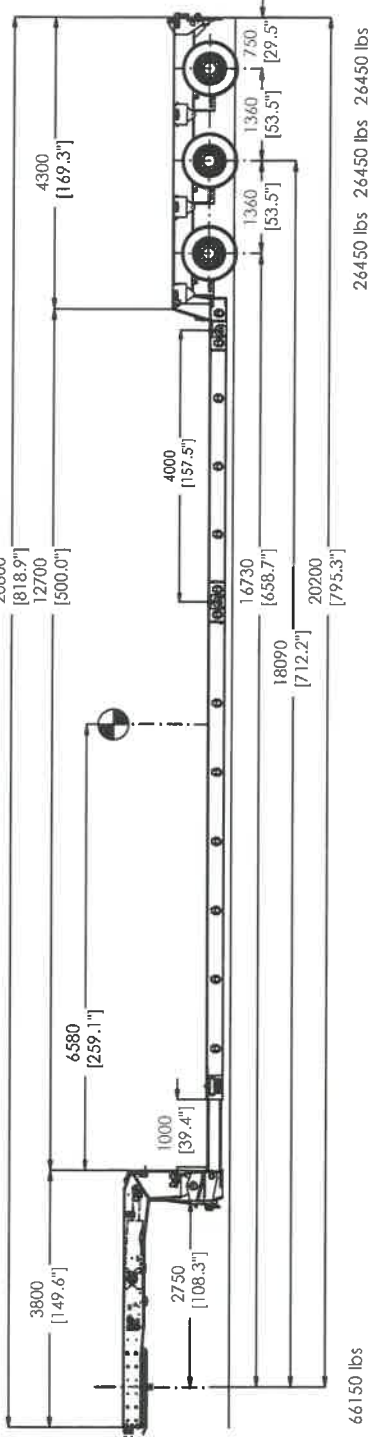

26450 lbs 26450 lbs 26450 lbs

Zeichnung : WWP_TBF-009650(50)		Rev.: 1
gez.	04.02.19	1:75 A3
gpr.	BSC	
Datum	Name	

Load Chart

Mega-Z-3(3+1))L-V-KBX-A-30AT-7.70-17.5-2.54-(US)

Faymonville Distribution AG  
 Duarretroos 8  
 L-9990 Weiswampach  
 Tel.: +352 / 26 90 04 155  
 Fax.: +352 / 26 90 04 425  
 E-Mail : general@faymonville.com  
 Web : www.faymonville.com



Caution : the load chart does not take the deflection of the lowbed into account. The deflection of the lowbed has a direct impact on the ground clearance and on the axle compensation.

1 2 3 4 5 6 7 8

payload on 2 supports (symmetric)

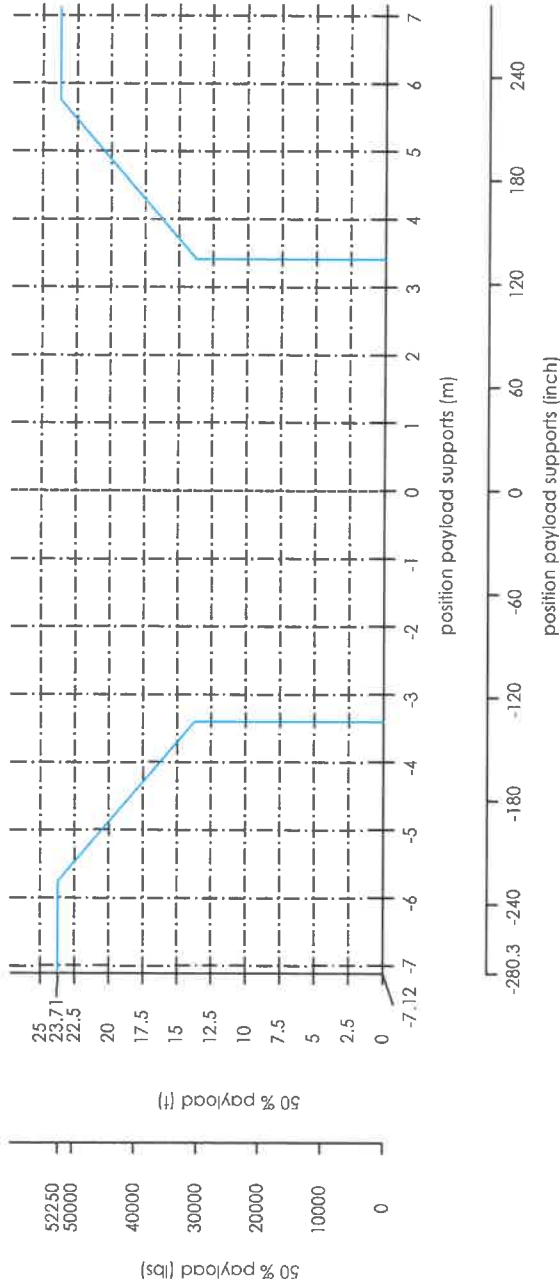

C.O.G.

(max. theoretical payload: 104500 lbs)

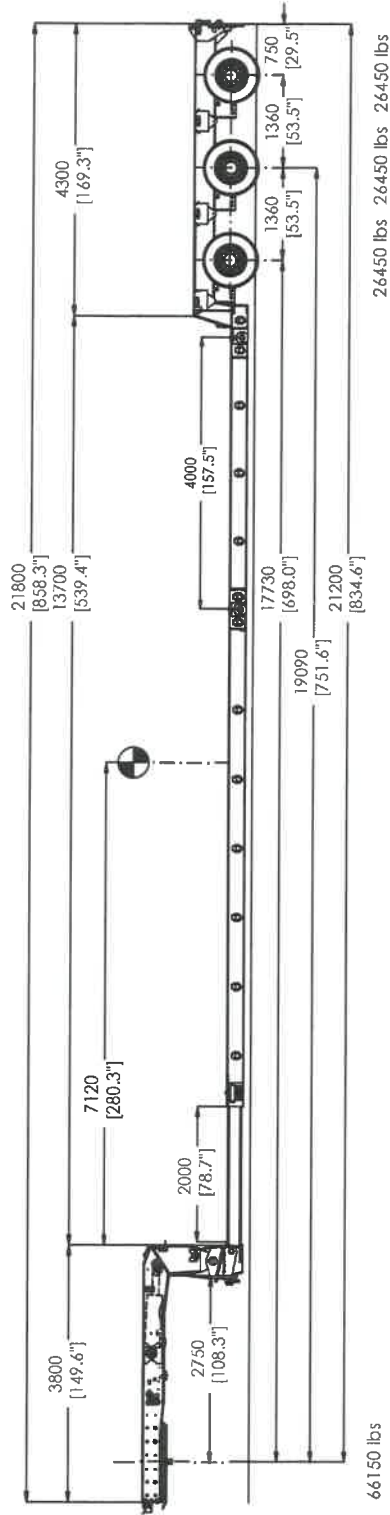

Zeichnung: WWP\_TBF-009650(51) Rev.:1

Datum	Name	Scale	Symbol
04.02.19	BSC	1:75	A3
gepr.			

Load Chart

Mega-Z-3(3+1))L-V-KBX-A-30AT-7.70-17.5-2.54-US

Faymonville Distribution AG  
 Duarretstroos 8  
 L-9990 Weiswampach  
 Tel.: +352 / 26 90 04 155  
 Fax.: +352 / 26 90 04 425  
 E-Mail: general@faymonville.com  
 Web: www.faymonville.com



Caution : the load chart does not take the deflection of the lowbed into account. The deflection of the lowbed has a direct impact on the ground clearance and on the axle compensation.

1 2 3 4 5 6 7 8

payload on 2 supports (symmetric)

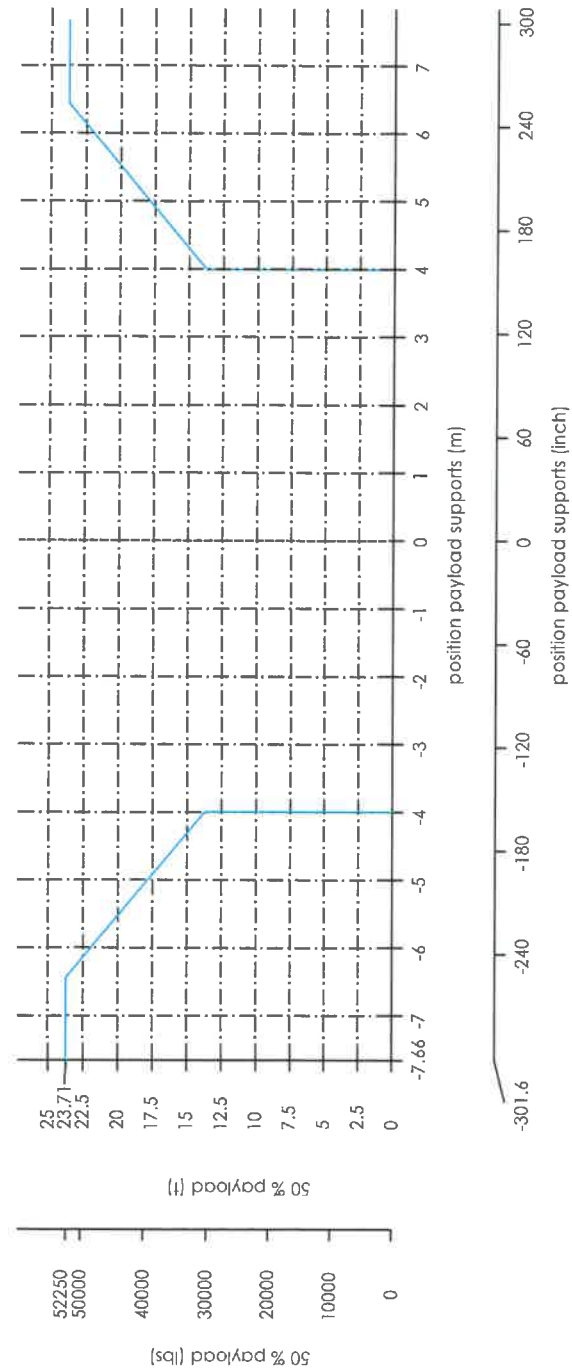

C.O.G.

(max. theoretical payload: 104500 lbs)

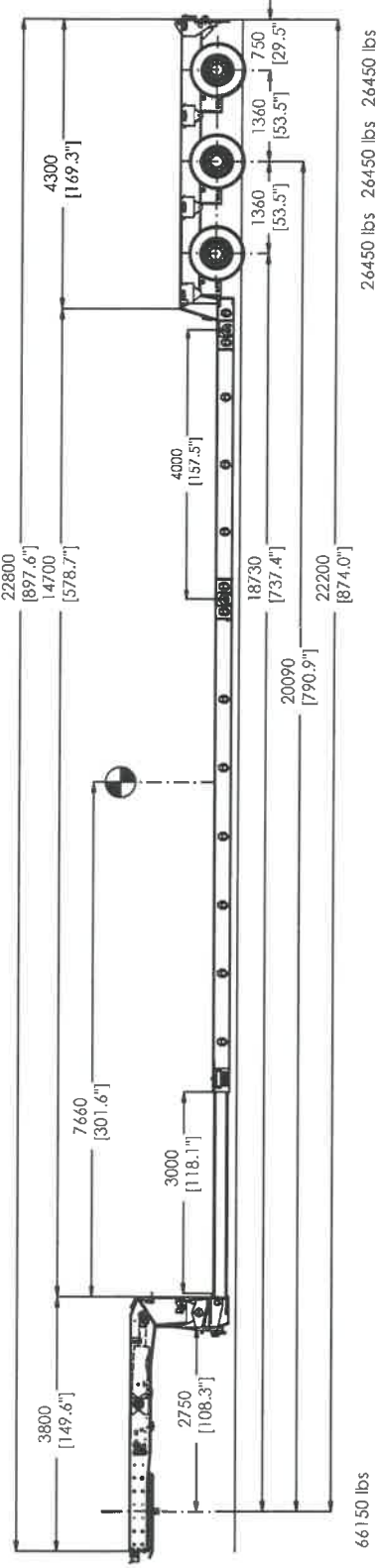

Zeichnung: WWP\_TBIF-009650(52) Rev.: 1

Datum	Name	1:75	A3
gez. 04.02.19	BSC		
gepr.			

**Load Chart**  
 Mega-Z-3(3+1) L-V-KBX-A-30AT-7.70-17.5-2.54-US  
 Faymonville Distribution AG  
 Duarretroos 8  
 L-9990 Weiswampach  
 Tel.: +352 / 26 90 04 155  
 Fax.: +352 / 26 90 04 425  
 E-Mail : general@faymonville.com  
 Web : www.faymonville.com



Caution : the load chart does not take the deflection of the lowbed into account. The deflection of the lowbed has a direct impact on the ground clearance and on the axle compensation.

1 2 3 4 5 6 7 8

payload on 2 supports (symmetric)

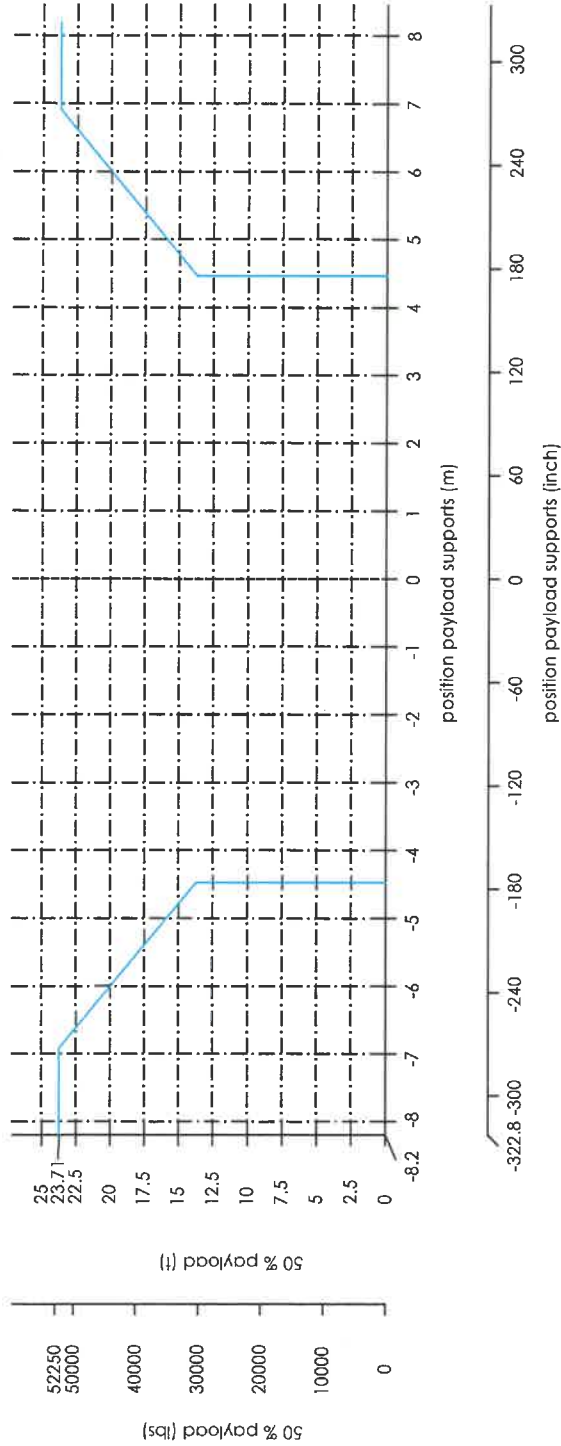

C.O.G.

(max. theoretical payload: 104500 lbs)

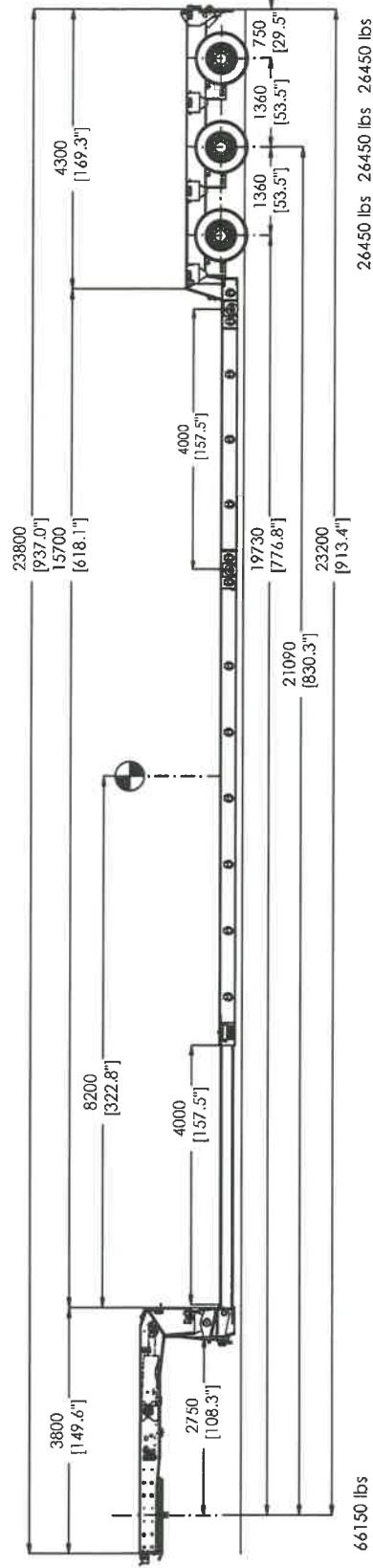

Zeichnung: WWF\_TBF-009650(53) Rev.: 1

gez.	04.02.19	Name	1:75 A3
gepr.			

**Load Chart**  
 Mega-Z-3(3+1) L-V-KBX-A-30A1-7.70-17.5-2.54-US  
 Faymonville Distribution AG  
 Duarrefstroos 8  
 L-9990 Weiswampach  
 Tel.: +352 / 26 90 04 155  
 Fax.: +352 / 26 90 04 425  
 E-Mail: general@faymonville.com  
 Web: www.faymonville.com



Caution : the load chart does not take the deflection of the lowbed into account. The deflection of the lowbed has a direct impact on the ground clearance and on the axle compensation.

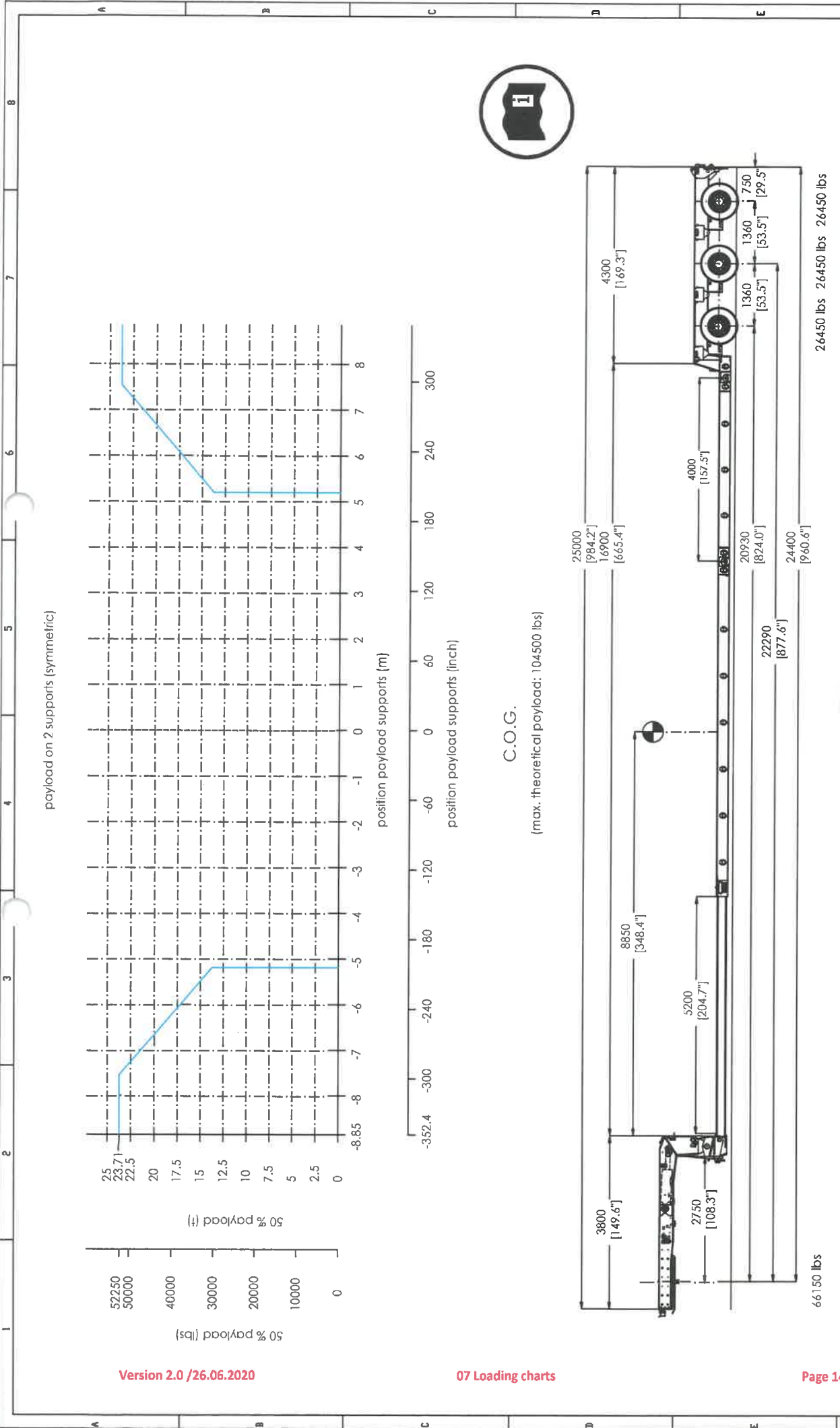

**Load Chart**

Zeichnung: WWP\_TBF-009650(54) Rev.:1

Datum	Name	1:75	A3
04.02.19	BSC		
gez.			
gepr.			

Mega-Z-3(3+1))L-V-KBX-A-30AT-1-70-17-5-2-54-(US)

Faymonville Distribution AG  
 Duarrefstrooss 8  
 L-9990 Weiswampach  
 Tel.: +352 / 26 90 04 155  
 Fax.: +352 / 26 90 04 425  
 E-Mail : general@faymonville.com  
 Web : www.faymonville.com

**FAYMONVILLE**  
TRAILERS TO THE MAX

Caution : the load chart does not take the deflection of the lowbed into account. The deflection of the lowbed has a direct impact on the ground clearance and on the axle compensation.

Version 2.0 /26.06.2020

07 Loading charts

Page 145 of 221

1 2 3 4 5 6 7 8

payload on 2 supports (symmetric)

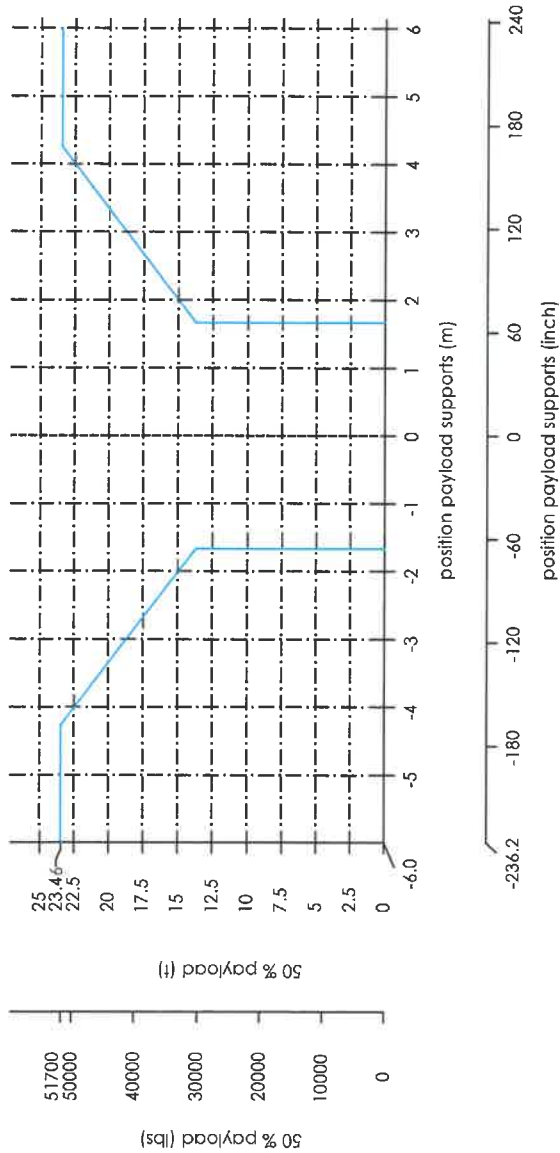

C.O.G.

[max. theoretical payload: 103400 lbs]

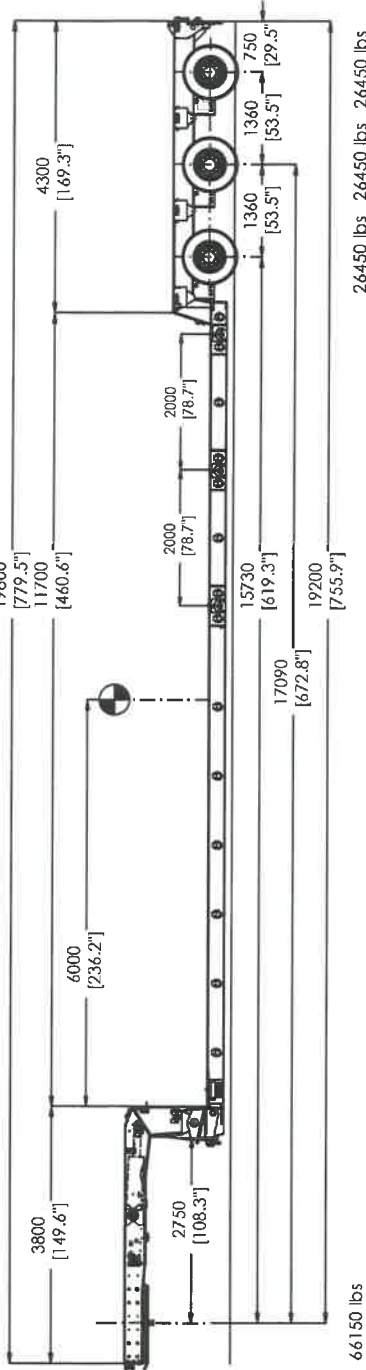

Zeichnung : WWP\_TBIF-009650(55) Rev.:1

Datum	Name	1:75	A3
gez. 04.02.19	BSC		
gepr.			

**Load Chart**  
**Mega-Z-3(3+1) L-V-KBX-A-30AT-7.70-17.5-2.54(US)**  
 Faymonville Distribution AG  
 Duarnestroos 8  
 L-9990 Weiswampach  
 Tel.: +352 / 26 90 04 155  
 Fax.: +352 / 26 90 04 425  
 E-Mail : general@faymonville.com  
 Web : www.faymonville.com



Caution : the load chart does not take the deflection of the lowbed into account. The deflection of the lowbed has a direct impact on the ground clearance and on the axle compensation.

1 2 3 4 5 6 7 8

payload on 2 supports (symmetric)

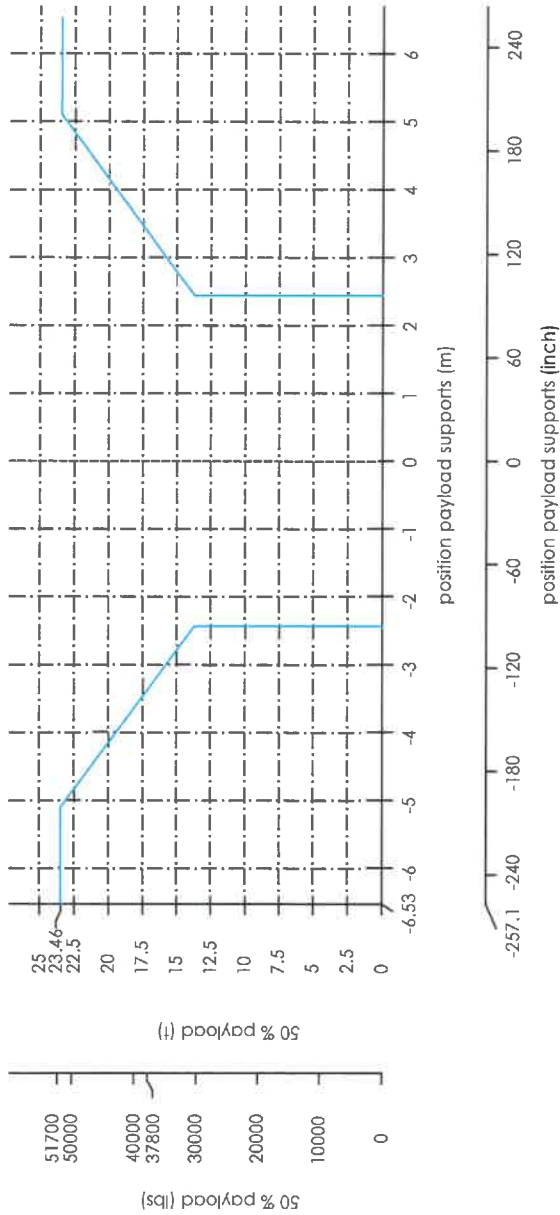

C.O.G.

(max. theoretical payload: 13400 lbs)

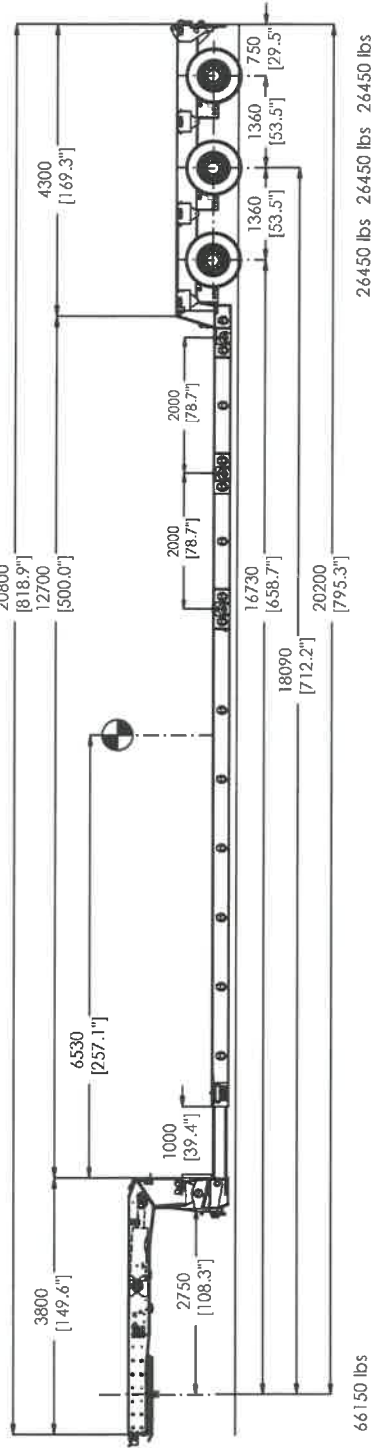

Zeichnung : WWP\_IBF-009650(56) Rev.:1

Datum	Name	1:75	A3
gez. 04.02.19	BSC		
gepr.			

Load Chart

Mega-Z-3(3+1) L-V-KBX-A-30A-T-7.70-17.5-2.54-US

Faymonville Distribution AG  
 Duarretstroos 8  
 L-9990 Weiswampach  
 Tel.: +352 / 26 90 04 155  
 Fax.: +352 / 26 90 04 425  
 E-Mail : general@faymonville.com  
 Web : www.faymonville.com



Caution : the load chart does not take the deflection of the lowbed into account. The deflection of the lowbed has a direct impact on the ground clearance and on the axle compensation.



payload on 2 supports (symmetric)

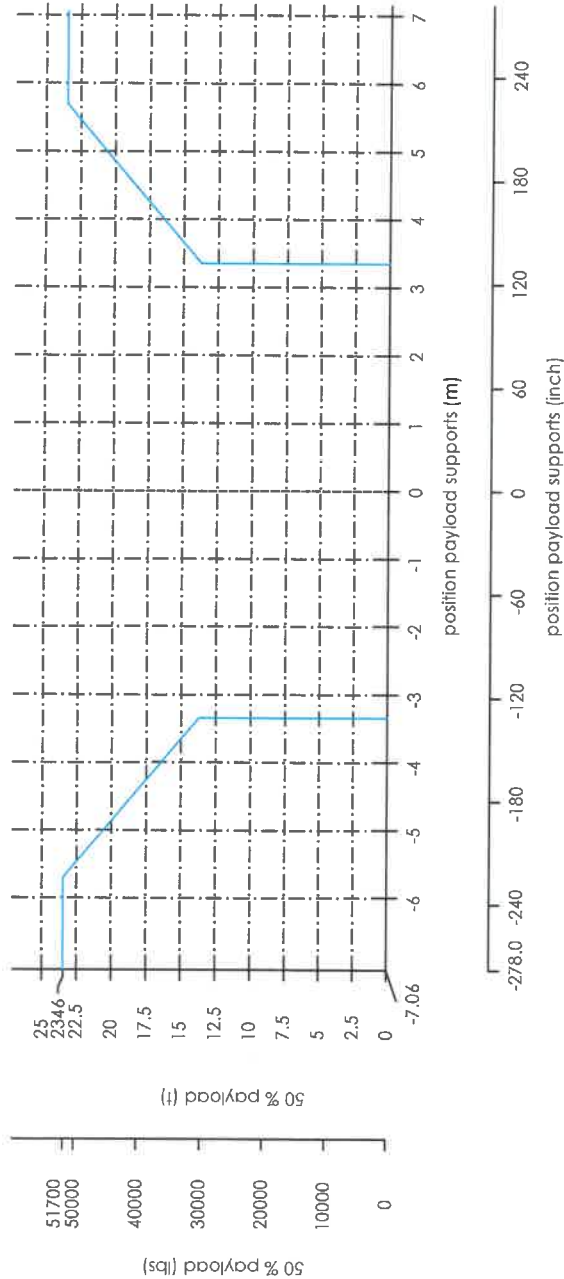

C.O.G.

(max. theoretical payload: 103400 lbs)

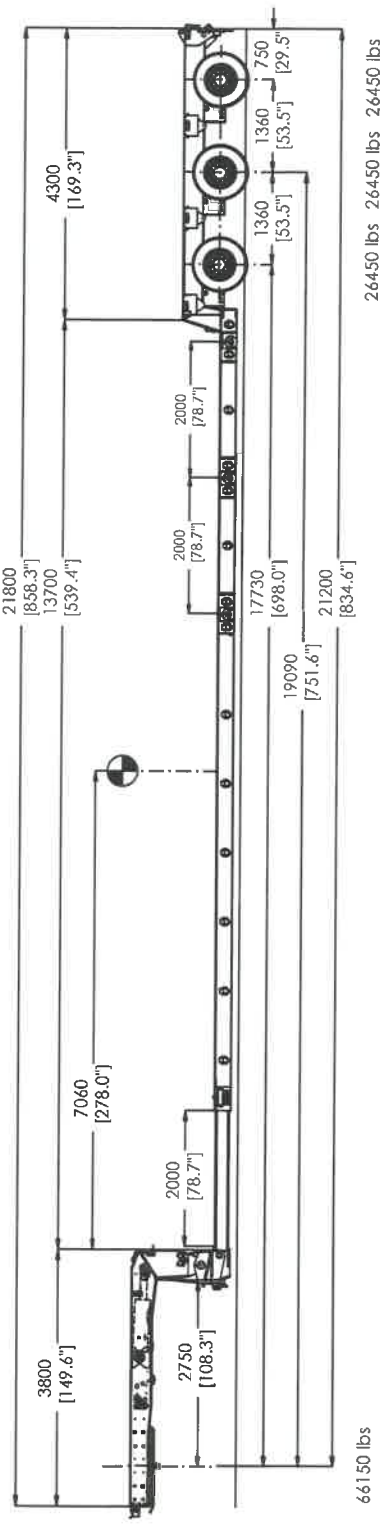

Zeichnung: WWP\_TBF-009650(57) Rev.: 1

Datum	Name	1:75	A3
04.02.19	BSC		
gepr.			

Load Chart

Mega-Z-3(3+1)|L-V-KBX-A-30AT-7.70-17.5-2.54-(US)  
 Faymonville Distribution AG  
 Duarrefstrooss 8  
 L-9990 Weiswampach  
 Tel.: +352 / 26 90 04 155  
 Fax.: +352 / 26 90 04 425  
 E-Mail: general@faymonville.com  
 Web: www.faymonville.com



Caution : the load chart does not take the deflection of the lowbed into account. The deflection of the lowbed has a direct impact on the ground clearance and on the axle compensation.

1 2 3 4 5 6 7 8

payload on 2 supports (symmetric)

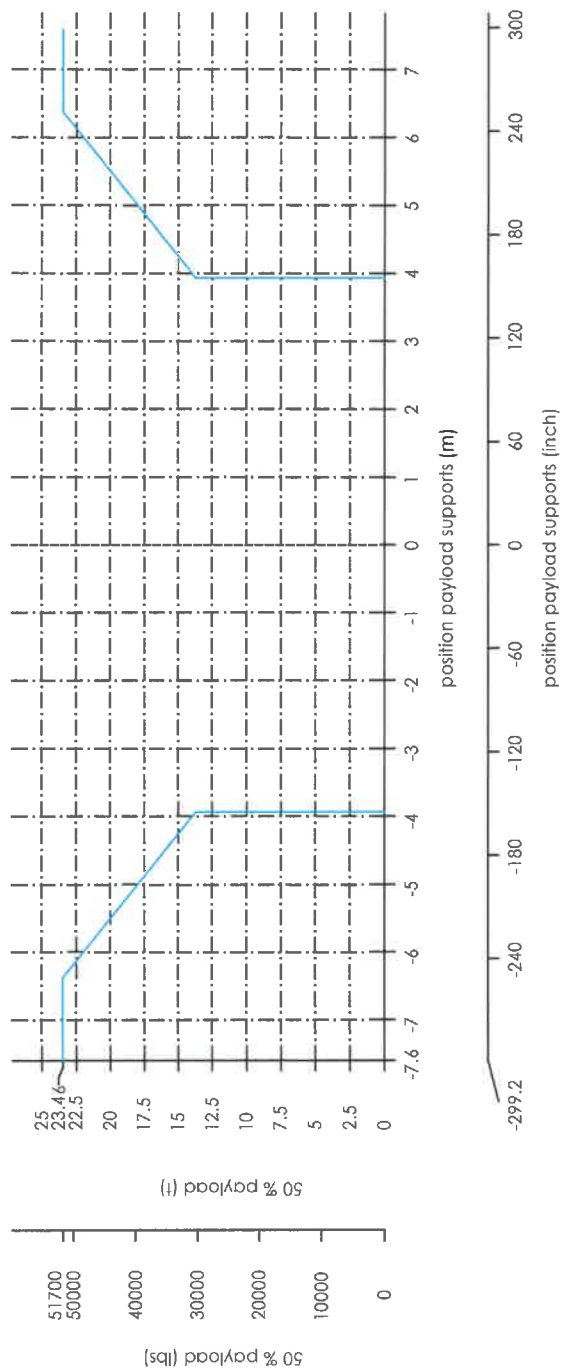

C.O.G.

(max. theoretical payload: 103400 lbs)

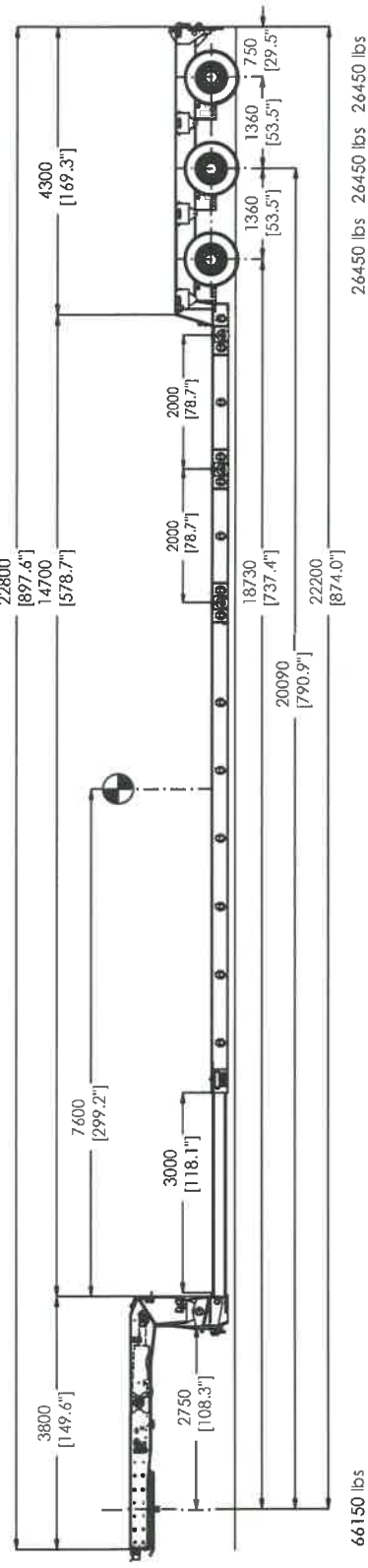

Zeichnung: WWF\_TBFB-009650(58) Rev.:1

Datum	Name	1:75	A3
gez. 04.02.19	BSC		
gepr.			

Load Chart

Mega-T-3(3+1)|L-V-KBX-A-30A|7.70-17.5-2.54-(US)

Faymonville Distribution AG  
 Ducarrelstroos 8  
 L-9990 Weiswampach  
 Tel.: +352 / 26 90 04 155  
 Fax.: +352 / 26 90 04 425  
 E-Mail: general@faymonville.com  
 Web: www.faymonville.com



Caution : the load chart does not take the deflection of the lowbed into account. The deflection of the lowbed has a direct impact on the ground clearance and on the axle compensation.



1 2 3 4 5 6 7 8

payload on 2 supports (symmetric)

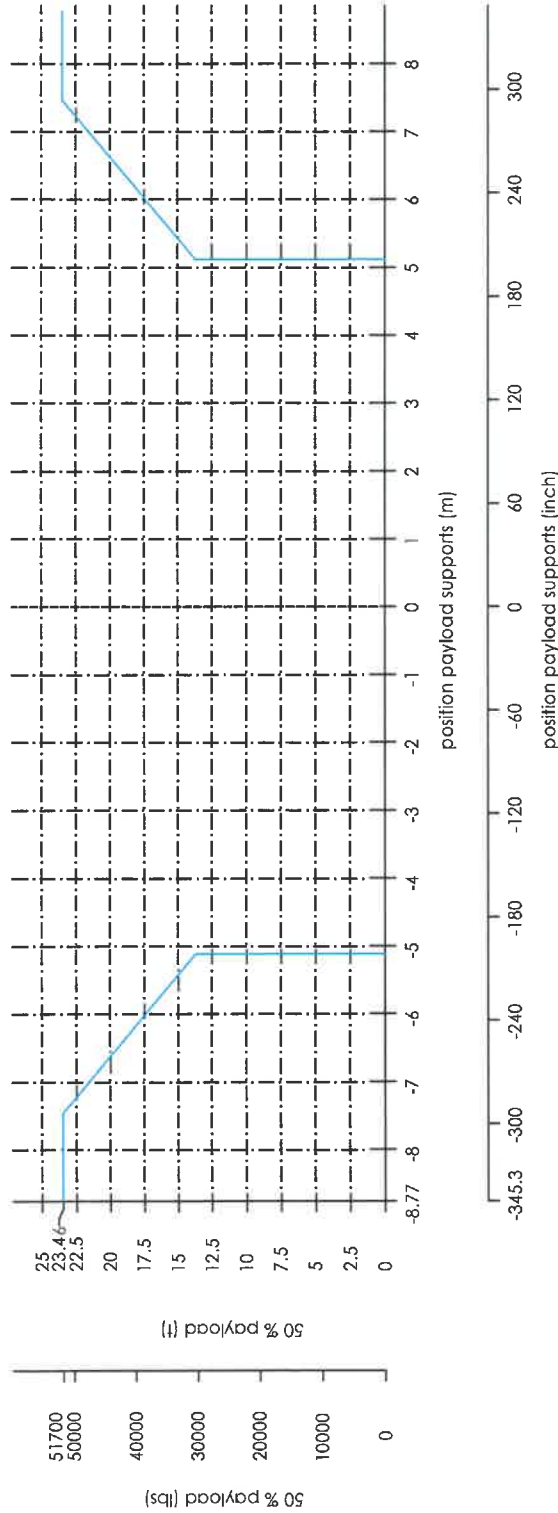

C.O.G.

(max. theoretical payload: 103400 lbs)

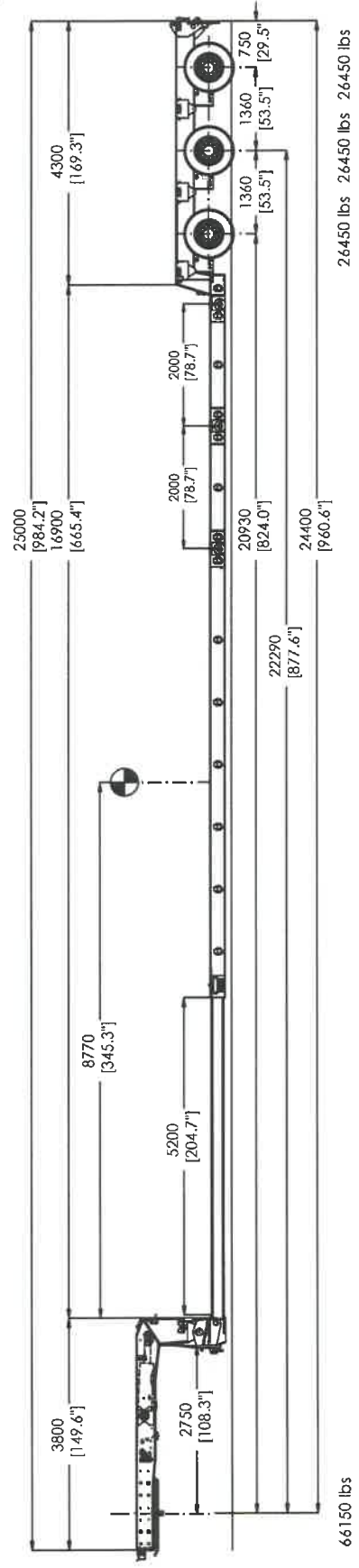

Zeichnung: WWP\_TBF-009650(60) Rev.: 1

Datum	Name	1:75	A3
04.02.19	BSC		
gepr.			

**Load Chart**  
 Mega-Z-3(3+1)-V-KBX-A-30AT-7.70-17.5-2.54-(US)  
 Faymonville Distribution AG  
 Duarrefstroos 8  
 L-9990 Weiswampach  
 Tel.: +352 / 26 90 04 155  
 Fax.: +352 / 26 90 04 425  
 E-Mail: general@faymonville.com  
 Web: www.faymonville.com



Caution : the load chart does not take the deflection of the lowbed into account. The deflection of the lowbed has a direct impact on the ground clearance and on the axle compensation.



1 2 3 4 5 6 7 8

payload on 2 supports (symmetric)

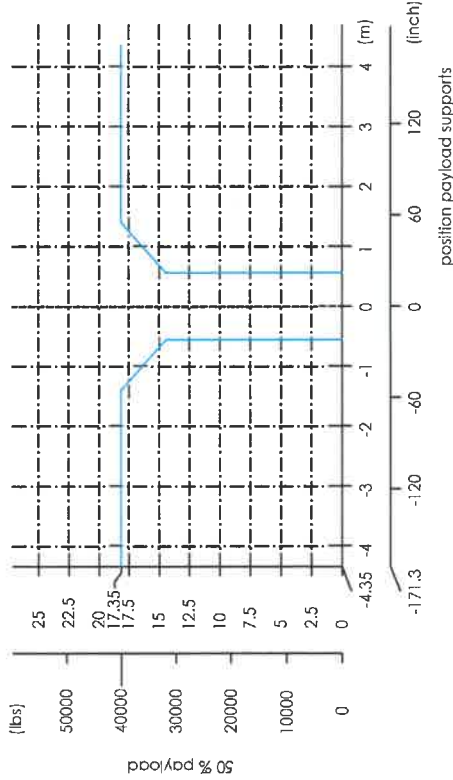

C.O.G.

(payload: 80000 lbs)

Middle of lowbed

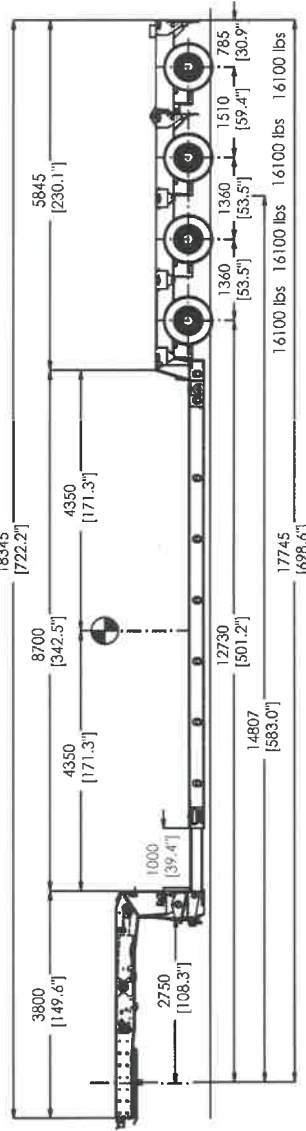

55100 lbs

53300 lbs ——— 20950 lbs 20950 lbs

**Load Chart**  
 Mega-Z-4(3+1)-V-KBX-A-30AT-7.70-17.5-2.54-(US)  
 Faymonville Distribution AG  
 Duarrestroos 8  
 L-9990 Weiswampach  
 Tel.: +352 / 26 90 04 155  
 Fax: +352 / 26 90 04 425  
 E-Mail: general@faymonville.com  
 Web: www.faymonville.com

Zeichnung: WWP_TBF-009648(2)		Rev.:-
Datum	Name	1:85 A3
gez. 17.01.19	BSC	
gepr.		



Caution : the load chart does not take the deflection of the lowbed into account.  
 The deflection of the lowbed has a direct impact on the ground clearance and on the axle compensation.

A B C D E F 1 2 3 4



1 2 3 4 5 6 7 8

payload on 2 supports (symmetric)

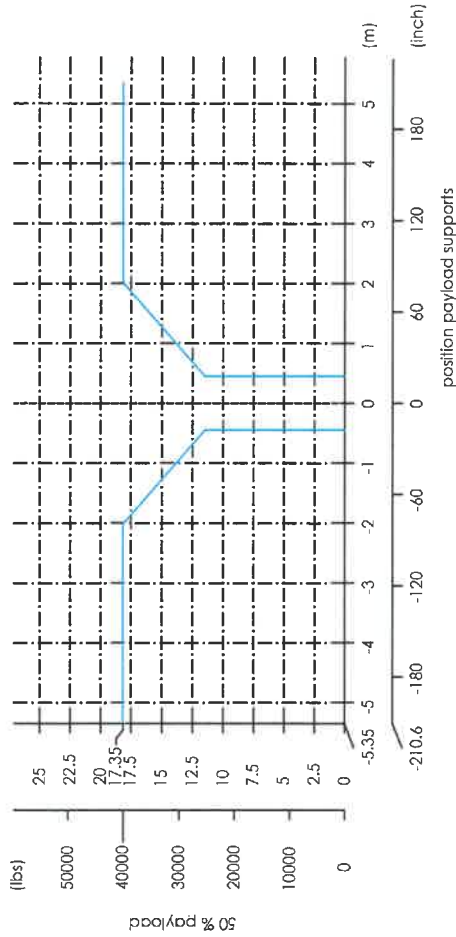

C.O.G.  
(payload: 80000 lbs)

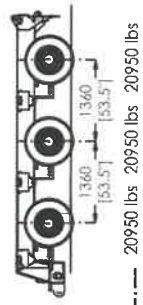
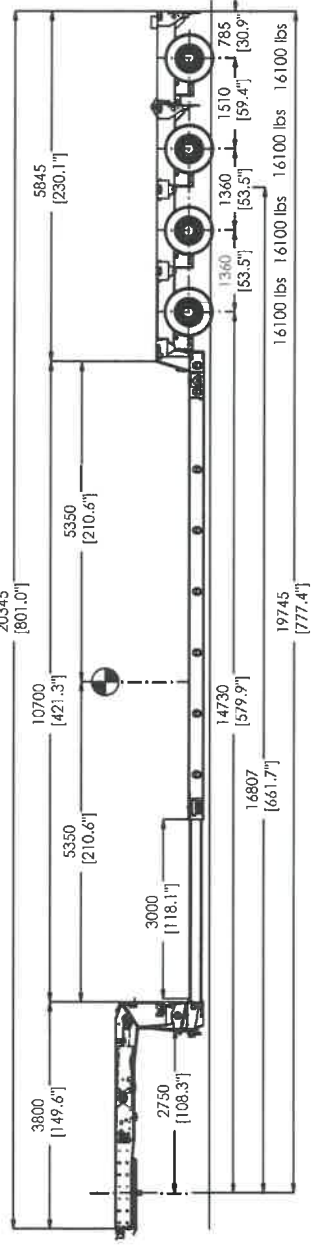

Zeichnung : WWP\_TBF-009648(4) Rev.:-

gepr.	Datum	Name	1:85	A3
	17.01.19	BSC		

**Load Chart**  
**Mega-7-4(3+1)L-V-KBX-A-30AT-7.70-17.5-2.54-(US)**  
 Faymonville Distribution AG  
 Duarretstroos 8  
 L-9990 Weiswampach  
 Tel.: +352 / 26 90 04 155  
 Fax.: +352 / 26 90 04 425  
 E-Mail : general@faymonville.com  
 Web : www.faymonville.com



Caution : the load chart does not take the deflection of the lowbed into account. The deflection of the lowbed has a direct impact on the ground clearance and on the axle compensation.



payload on 2 supports (symmetric)

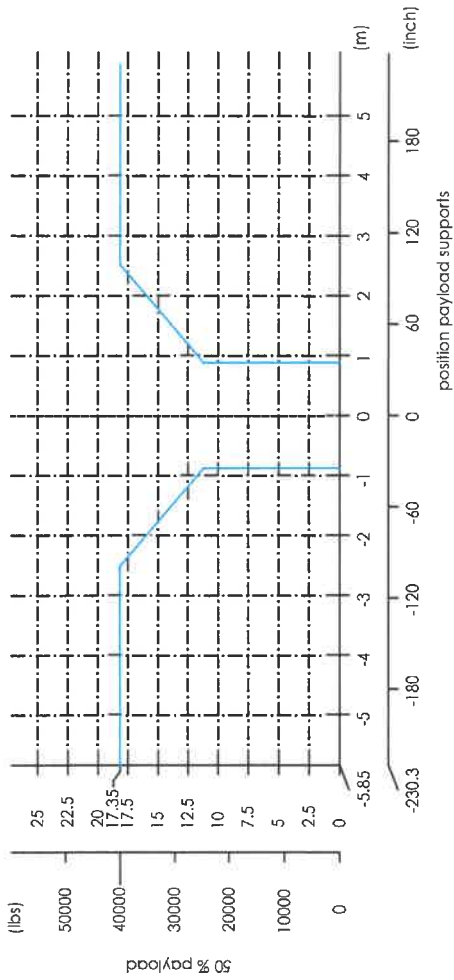

C.O.G.

(payload: 80000 lbs)

Middle of lowbed

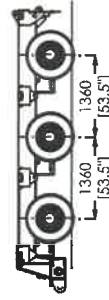
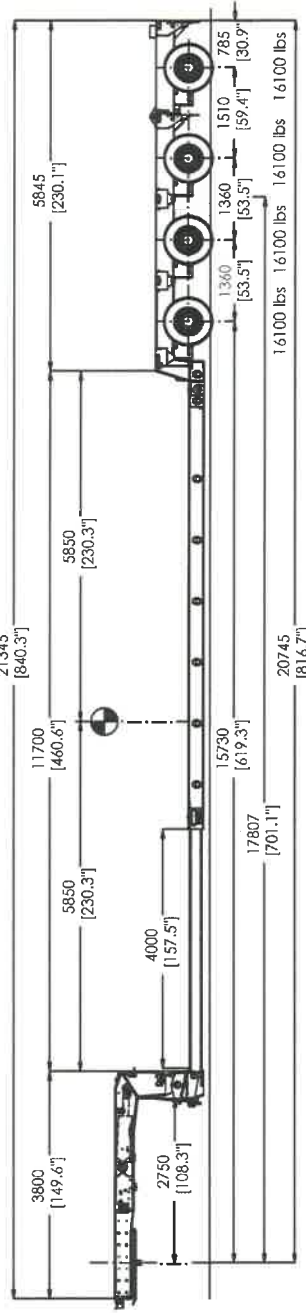

20950 lbs 20950 lbs 20950 lbs

Zeichnung: WWP\_IBF-009648(5)

Rev.:-

Load Chart  
 Mega-Z-4(3+1)-V-KBX-A-30AT-7.70-17.5-2.54-[US]  
 Faymonville Distribution AG  
 Duarrefströos 8  
 L-9990 Weiswampach  
 Tel.: +352 / 26 90 04 155  
 Fax.: +352 / 26 90 04 425  
 E-Mail: general@faymonville.com  
 Web: www.faymonville.com

Datum	Name	Rev.
gez. 17.01.19	BSC	1:85 A3
gepr.		



Caution: the load chart does not take the deflection of the lowbed into account. The deflection of the lowbed has a direct impact on the ground clearance and on the axle compensation.

1 2 3 4 5 6 7

payload on 2 supports (symmetric)

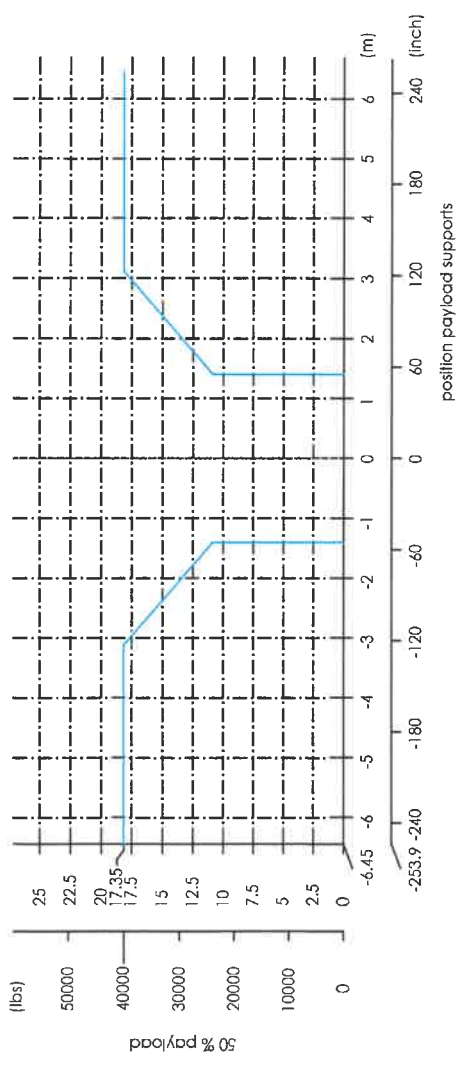

C.O.G.  
(payload: 80000 lbs)

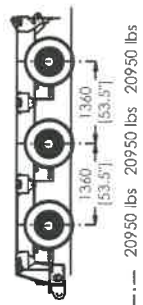
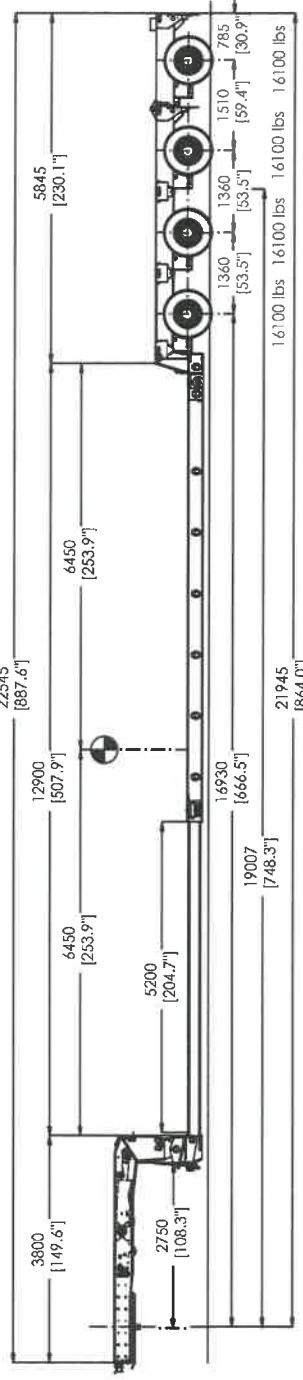

**Load Chart**  
 Mega-Z-4(3+1)-V-KBX-A-30AT-7.70-17.5-2.54-(US)  
 Faymonville Distribution AG  
 Duarretstroos 8  
 L-9990 Weiswampach  
 Tel.: +352 / 26 90 04 155  
 Fax.: +352 / 26 90 04 425  
 E-Mail : general@faymonville.com  
 Web : www.faymonville.com

Zeichnung : WWP\_TBF-009648(6) Rev.:-

Datum	Name	Rev.
gez. 17.01.19	BSC	1.85 A3
gepr.		



Caution : the load chart does not take the deflection of the lowbed into account. The deflection of the lowbed has a direct impact on the ground clearance and on the axle compensation.

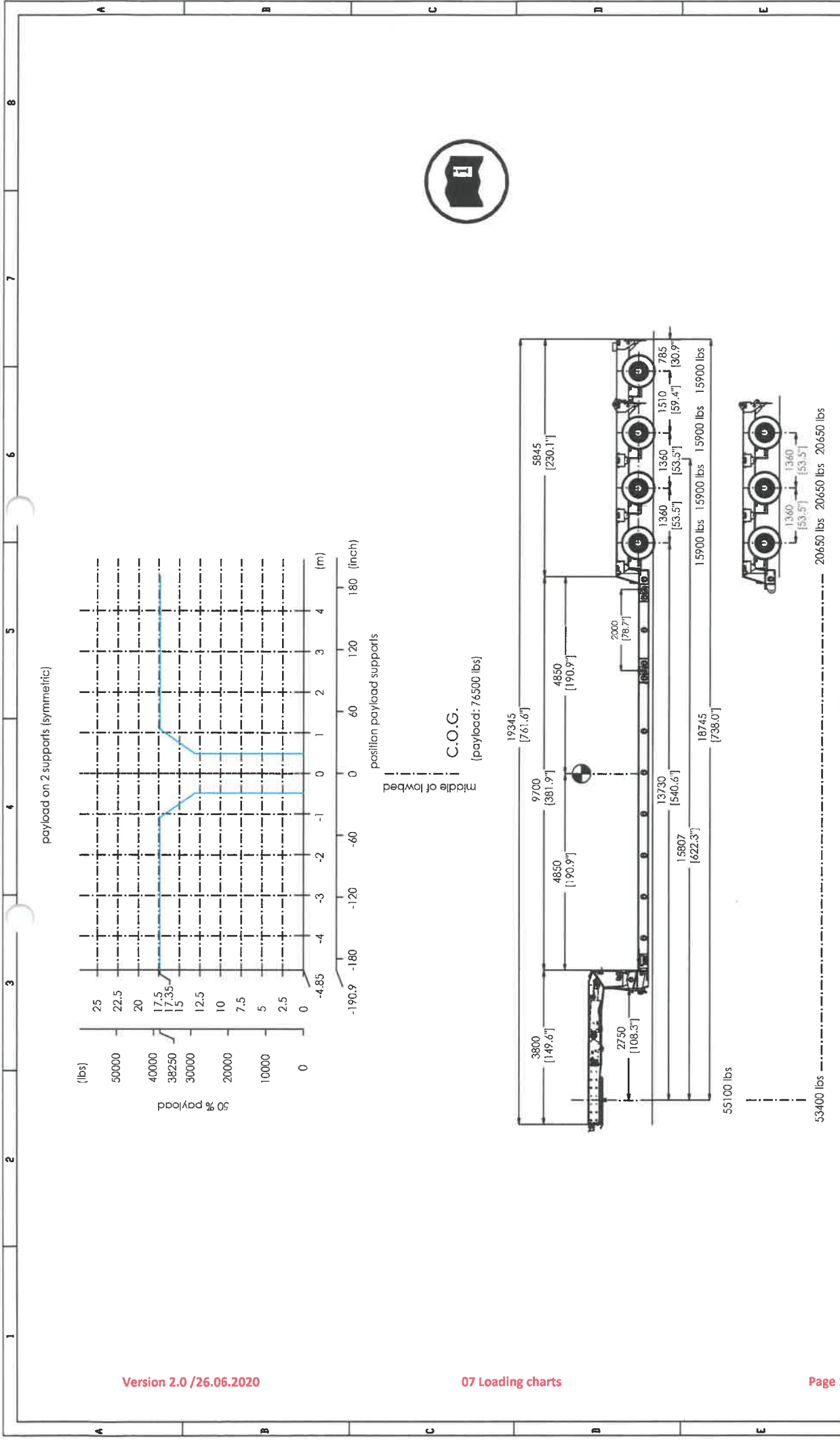

**Load Chart**  
 Mega-Z-4(3+1)-V-KBX-A-30AT-7.70-17.5-2.54-(US)  
 Faymonville Distribution AG  
 Duarretstrass 8  
 L-9990 Weiswampach  
 Tel.: +352 / 26 90 04 155  
 Fax.: +352 / 26 90 04 425  
 E-Mail : general@faymonville.com  
 Web : www.faymonville.com

Zeichnung: WWP_TBF-009648(7)		Rev.:-	
Datum	Name	1:85	A3
gez. 17.01.19	BSC		
gepr.			



Caution : the load chart does not take the deflection of the lowbed into account.  
 The deflection of the lowbed has a direct impact on the ground clearance and on the axle compensation.

payload on 2 supports (symmetric)

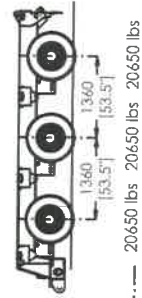
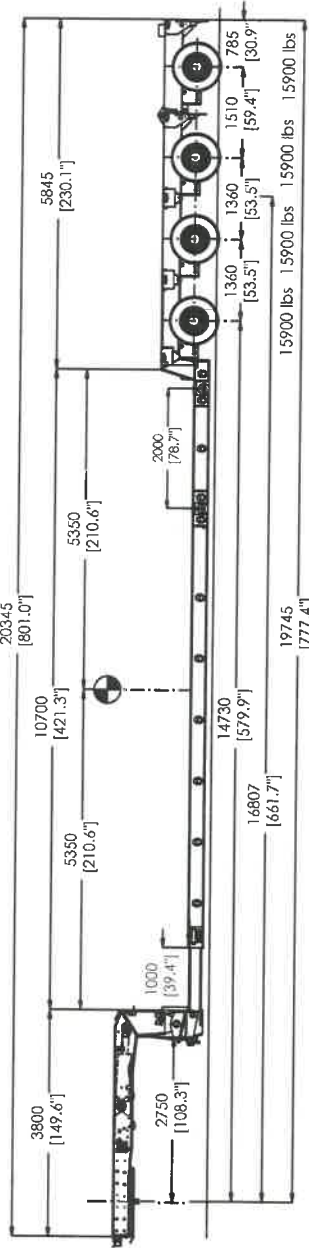
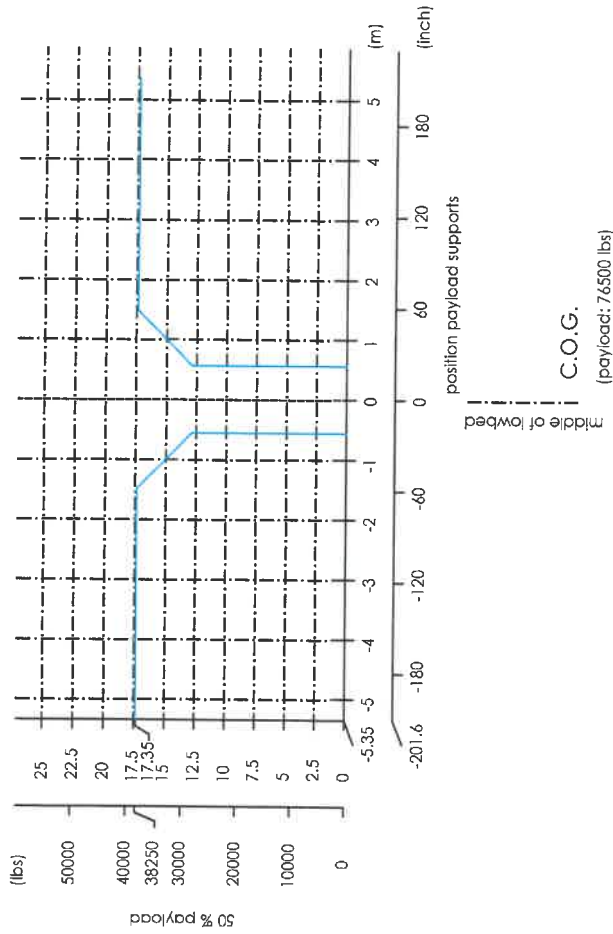

Zeichnung: WWP_TBF-009648 (8)		Rev.:-	
Datum	Name	1:85	A3
gez. 17.01.19	BSC		
gepr.			

**Load Chart**  
 Mega-Z-4(3+1)-V-KBX-A-30A1-7.70-17.5-2.54-(US)  
 Faymonville Distribution AG  
 Duarrefstrooss 8  
 L-9990 Weiswampach  
 Tel.: +352 / 26 90 04 155  
 Fax.: +352 / 26 90 04 425  
 E-Mail : general@faymonville.com  
 Web : www.faymonville.com



Caution : the load chart does not take the deflection of the lowbed into account. The deflection of the lowbed has a direct impact on the ground clearance and on the axle compensation.

payload on 2 supports (symmetric)

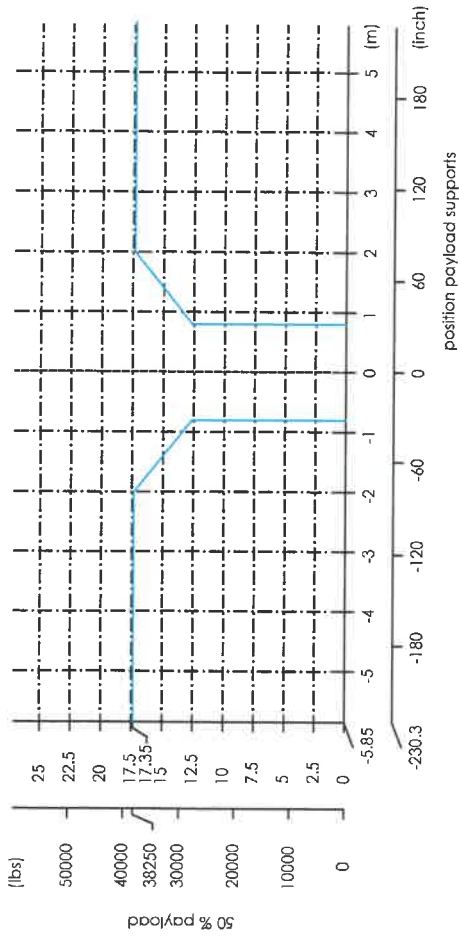

C.O.G.

(payload: 76500 lbs)

middle of lowbed

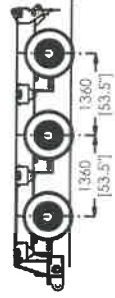
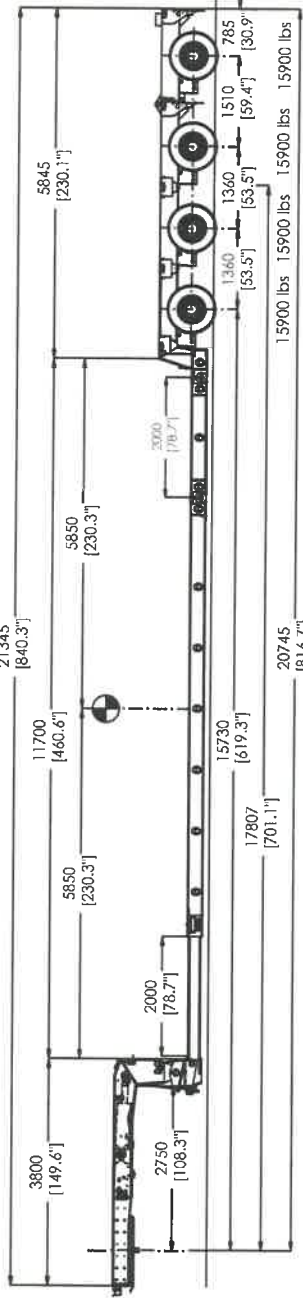

53400 lbs 20650 lbs 20650 lbs 20650 lbs

Zeichnung: WWP\_IBF-009648(9)

Rev.:-

Datum	Name	1:85	A3
gez. 17.01.19	BSC		
gepr.			

Load Chart

Mega-Z-4(3+)|L-V-KBX-A-30AT-7.70-17.5-2.54-(US)

Faymonville Distribution AG  
 Duarrestrooss 8  
 L-9990 Weiswampach  
 Tel.: +352 / 26 90 04 155  
 Fax.: +352 / 26 90 04 425  
 E-Mail : general@faymonville.com  
 Web : www.faymonville.com



Caution : the load chart does not take the deflection of the lowbed into account.  
 The deflection of the lowbed has a direct impact on the ground clearance and on the axle compensation.

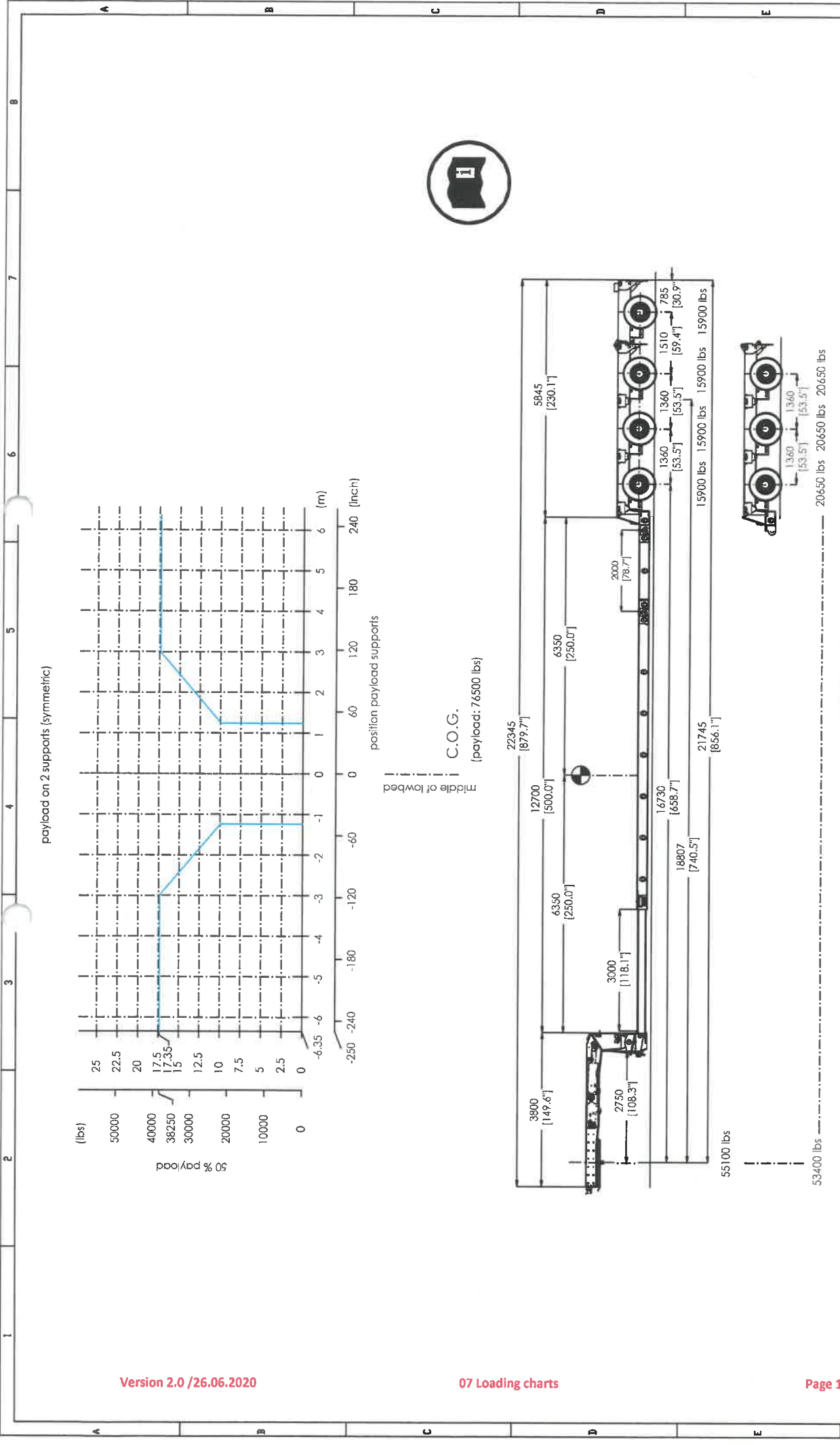

C.O.G.  
(payload: 76500 lbs)

**Load Chart**  
 Mega-Z-4(3+1)-V-KBX-A-30A1-7.70-17.5-2.54-(US)  
 Faymonville Distribution AG  
 Duarretroos 8  
 L-9990 Weiswampach  
 Tel.: +352 / 26 90 04 155  
 Fax.: +352 / 26 90 04 425  
 E-Mail : general@faymonville.com  
 Web : www.faymonville.com

Zeichnung : WWP_TBF-009648(10)		Rev.:-	
gez.	Datum	Name	1:85 A3
gep.	17.01.19	BSC	



Caution : the load chart does not take the deflection of the lowbed into account.  
 The deflection of the lowbed has a direct impact on the ground clearance and on the axle compensation.

payload on 2 supports (symmetric)

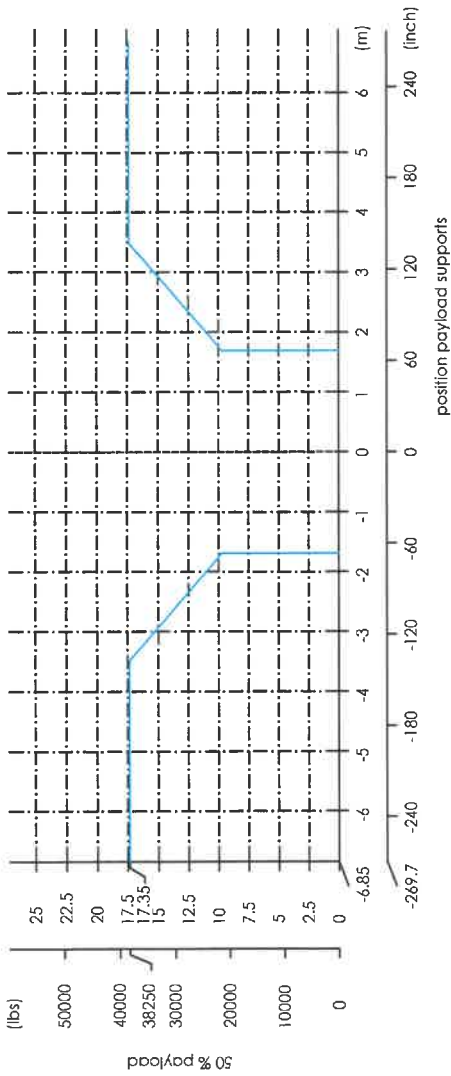

C.O.G.

(payload: 76500 lbs)

middle of lowbed

position payload supports

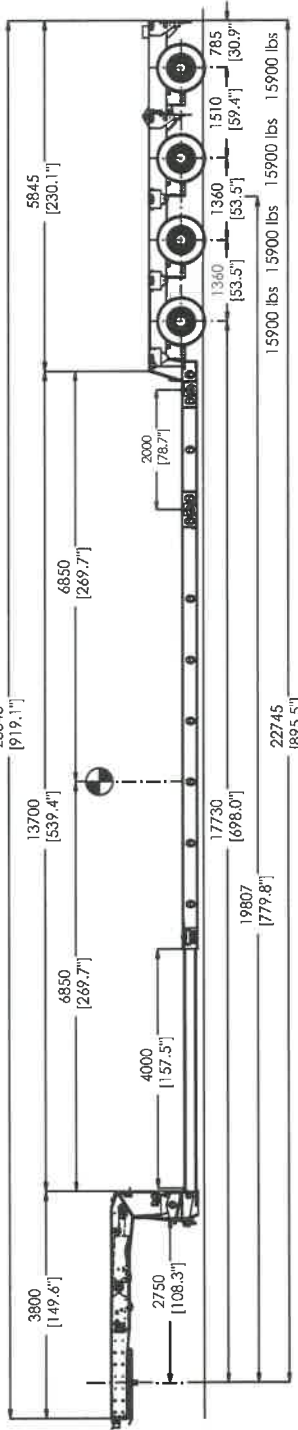

20650 lbs 20650 lbs 20650 lbs

Zeichnung: WWP\_TBF-009648(11)

Rev.:-

Load Chart  
 Mega-Z-4(3+)-V-KBX-A-30AT-7.70-17.5-2.54-(US)

Faymonville Distribution AG  
 Duarrefstross 8  
 L-9990 Weiswampach  
 Tel.: +352 / 26 90 04 155  
 Fax.: +352 / 26 90 04 425  
 E-Mail: general@faymonville.com  
 Web: www.faymonville.com

Datum	Name	Rev.
17.01.19	BSC	185 A3



Caution : the load chart does not take the deflection of the lowbed into account.  
 The deflection of the lowbed has a direct impact on the ground clearance and on the axle compensation.

payload on 2 supports (symmetric)

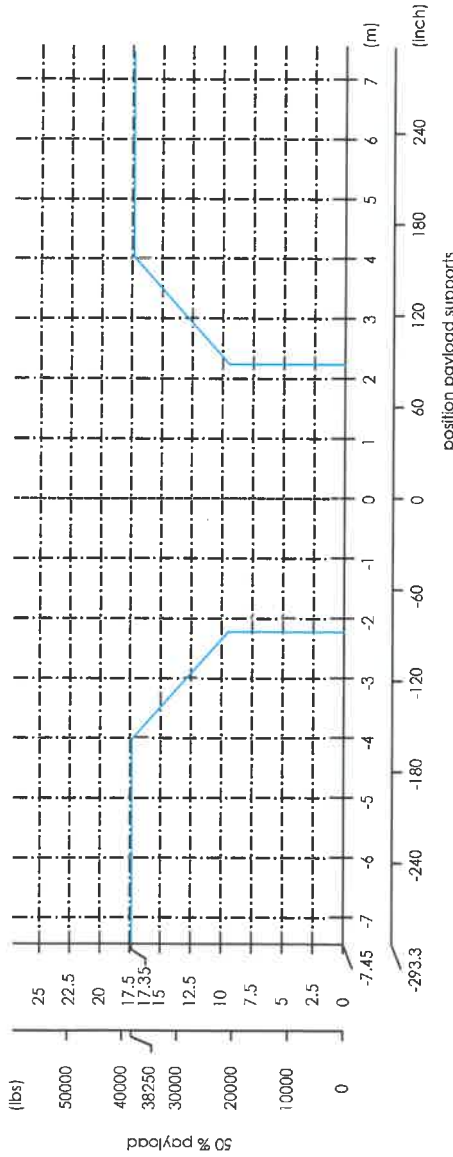

C.O.G.  
(payload: 76500 lbs)

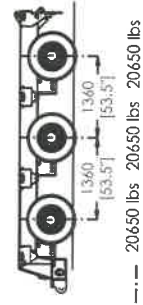
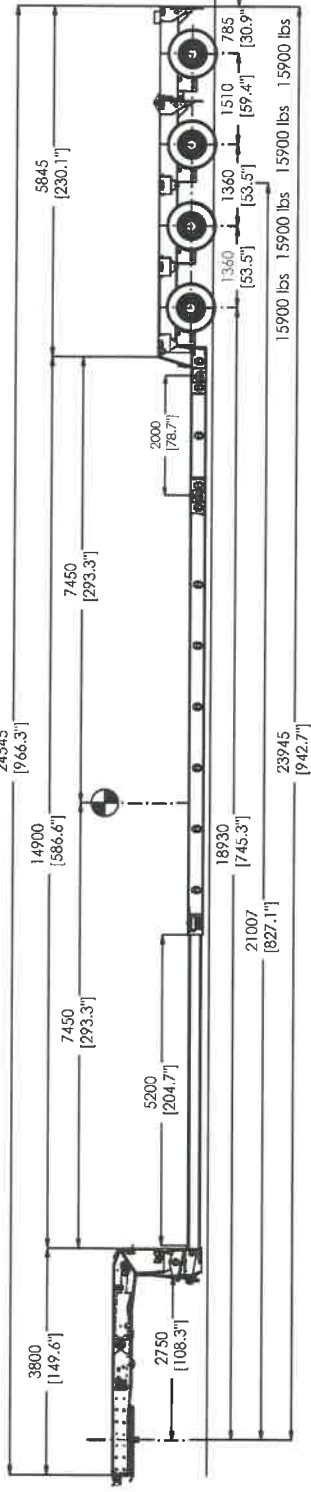

Zeichnung : WWP\_TBF-009648(12) Rev.:-

gez.	Datum	Name	1:85	A3
	17.01.19	BSC		
gepr.				

**Load Chart**  
 Mega-Z-4(3+1)-V-KBX-A-30AT-7.70-17.5-2.54-(US)  
 Faymonville Distribution AG  
 Duarrefstrooss 8  
 L-9990 Weiswampach  
 Tel.: +352 / 26 90 04 155  
 Fax.: +352 / 26 90 04 425  
 E-Mail : general@faymonville.com  
 Web : www.faymonville.com



Caution : the load chart does not take the deflection of the lowbed into account. The deflection of the lowbed has a direct impact on the ground clearance and on the axle compensation.



payload on 2 supports (symmetric)

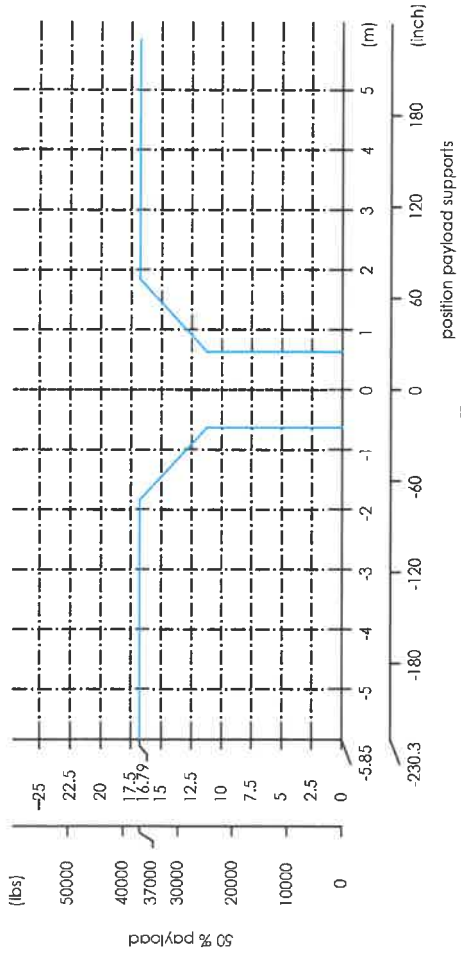

C.O.G.  
[payload: 74000 lbs]

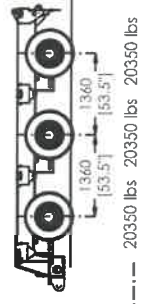
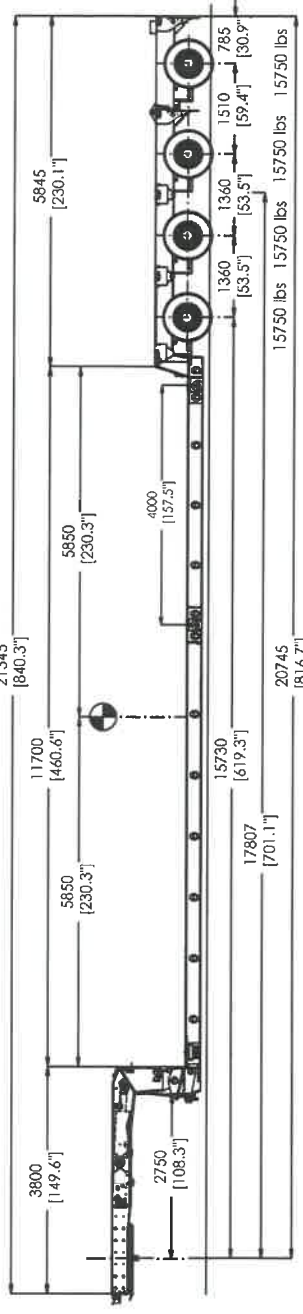

Zeichnung: WWP\_TBF-009648(13) Rev.:-

gez.	Datum	Name	1:85	A3
gez.	17.01.19	BSC		
gsp.				

**Load Chart**  
 Mega-Z-4(3+1) L-V-KBX-A-30AT-7-70-17-5-2-54-US  
 Fayonville Distribution AG  
 Duarretroos 8  
 L-9990 Weiswampach  
 Tel.: +352 / 26 90 04 155  
 Fax.: +352 / 26 90 04 425  
 E-Mail : general@fayonville.com  
 Web : www.fayonville.com



Caution : the load chart does not take the deflection of the lowbed into account. The deflection of the lowbed has a direct impact on the ground clearance and on the axle compensation.

payload on 2 supports (symmetric)

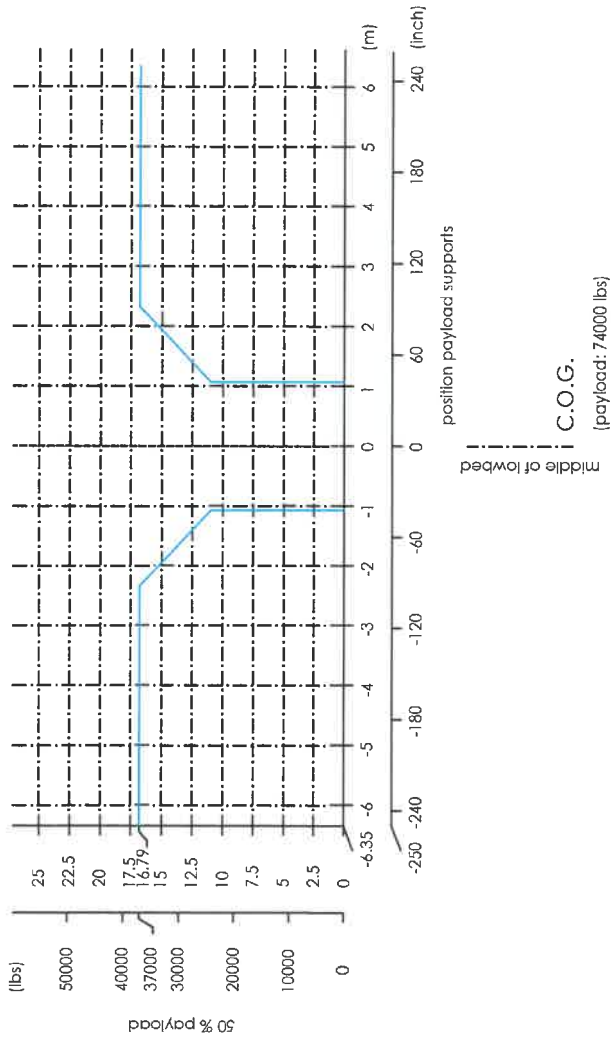

C.O.G.  
[payload: 74000 lbs]

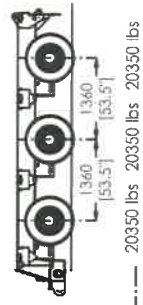
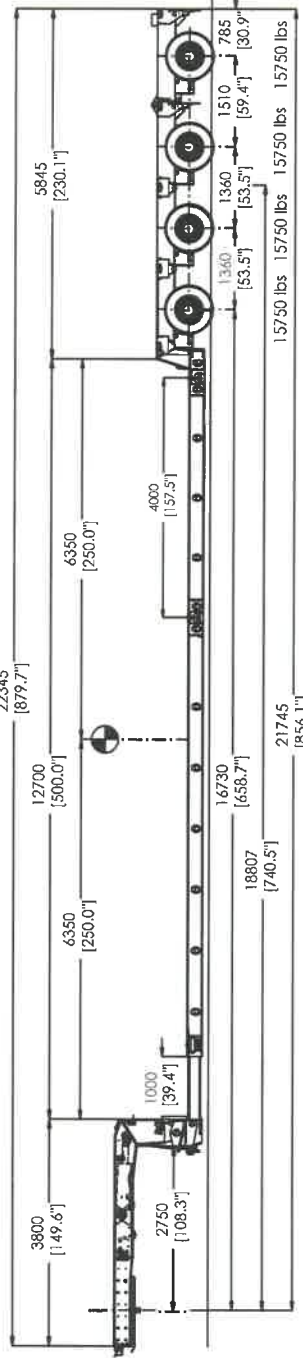

**Load Chart**  
 Mega-Z-4(3+1)L-V-KBX-A-30AT-7.70-17.5-2.54-US  
 Faymonville Distribution AG  
 Duarretroos 8  
 L-9990 Weiswampach  
 Tel.: +352 / 26 90 04 155  
 Fax.: +352 / 26 90 04 425  
 E-Mail : general@faymonville.com  
 Web : www.faymonville.com

Zeichnung : WWP\_TBF-009648(1/4) Rev.:-

Datum	Name	Rev.
gez. 17.01.19	BSC	1:85 A3
gepr.		



Caution : the load chart does not take the deflection of the lowbed into account. The deflection of the lowbed has a direct impact on the ground clearance and on the axle compensation.

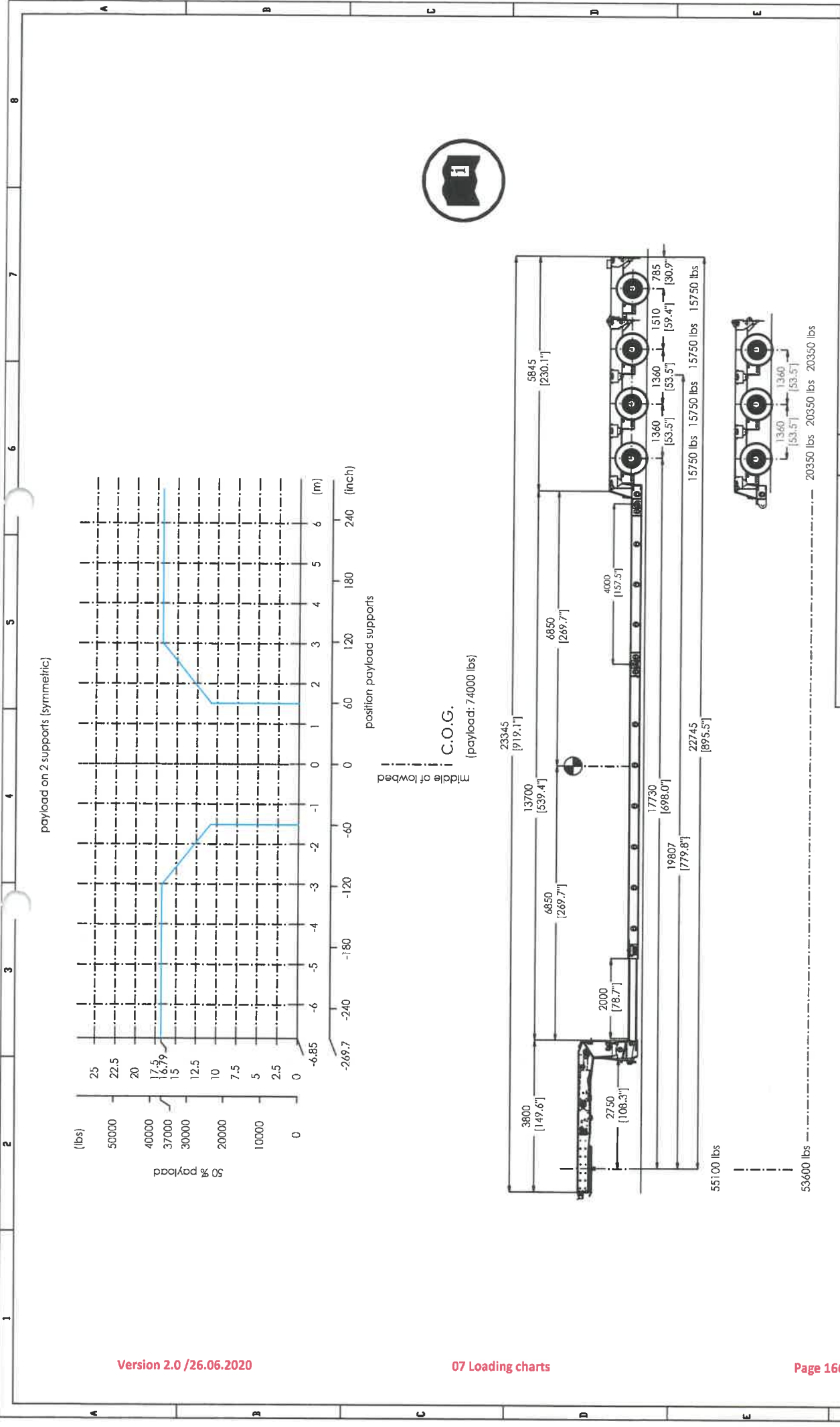

**Load Chart**  
 Mega-Z-4(3+1)-L-V-KBX-A-30A1-7.70-17.5-2.54-(US)  
 Faymonville Distribution AG  
 Duarrefstrooss 8  
 L-9990 Weiswampach  
 Tel.: +352 / 26 90 04 155  
 Fax.: +352 / 26 90 04 425  
 E-Mail : general@faymonville.com  
 Web : www.faymonville.com

Zeichnung : WWP\_TBF-009648(15) Rev.:-

Datum	Name	1:85	A3
gez. 17.01.19	BSC		
gepr.			



Caution : the load chart does not take the deflection of the lowbed into account. The deflection of the lowbed has a direct impact on the ground clearance and on the axle compensation.

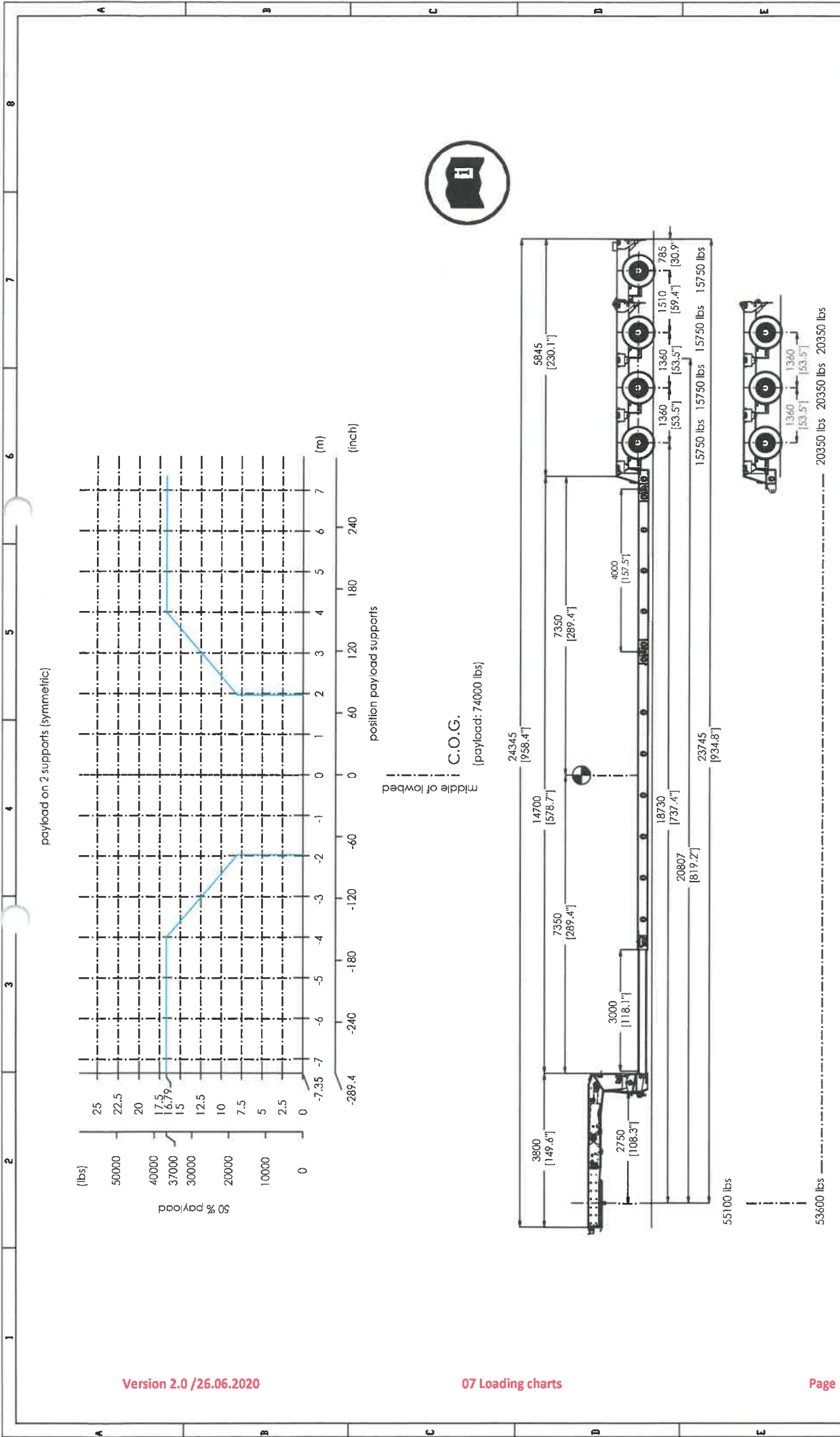

**Load Chart**

Mega-Z-4(3+1)-V-KBX-A-30AT-7.70-17.5-2.54-US)

Faymonville Distribution AG  
 Duarretfrooss 8  
 L-9990 Weiswampach  
 Tel.: +352 / 26 90 04 155  
 Fax.: +352 / 26 90 04 425  
 E-Mail : general@faymonville.com  
 Web : www.faymonville.com

Zeichnung : WWP\_TBF-009648(1/6) Rev.:-

Datum	Name	1:85	A3
gez. 17.01.19	BSC		
gipi.			

**FAYMONVILLE**  
 TAKES TO THE MAX

Caution : the load chart does not take the deflection of the lowbed into account.  
 The deflection of the lowbed has a direct impact on the ground clearance and on the axle compensation.

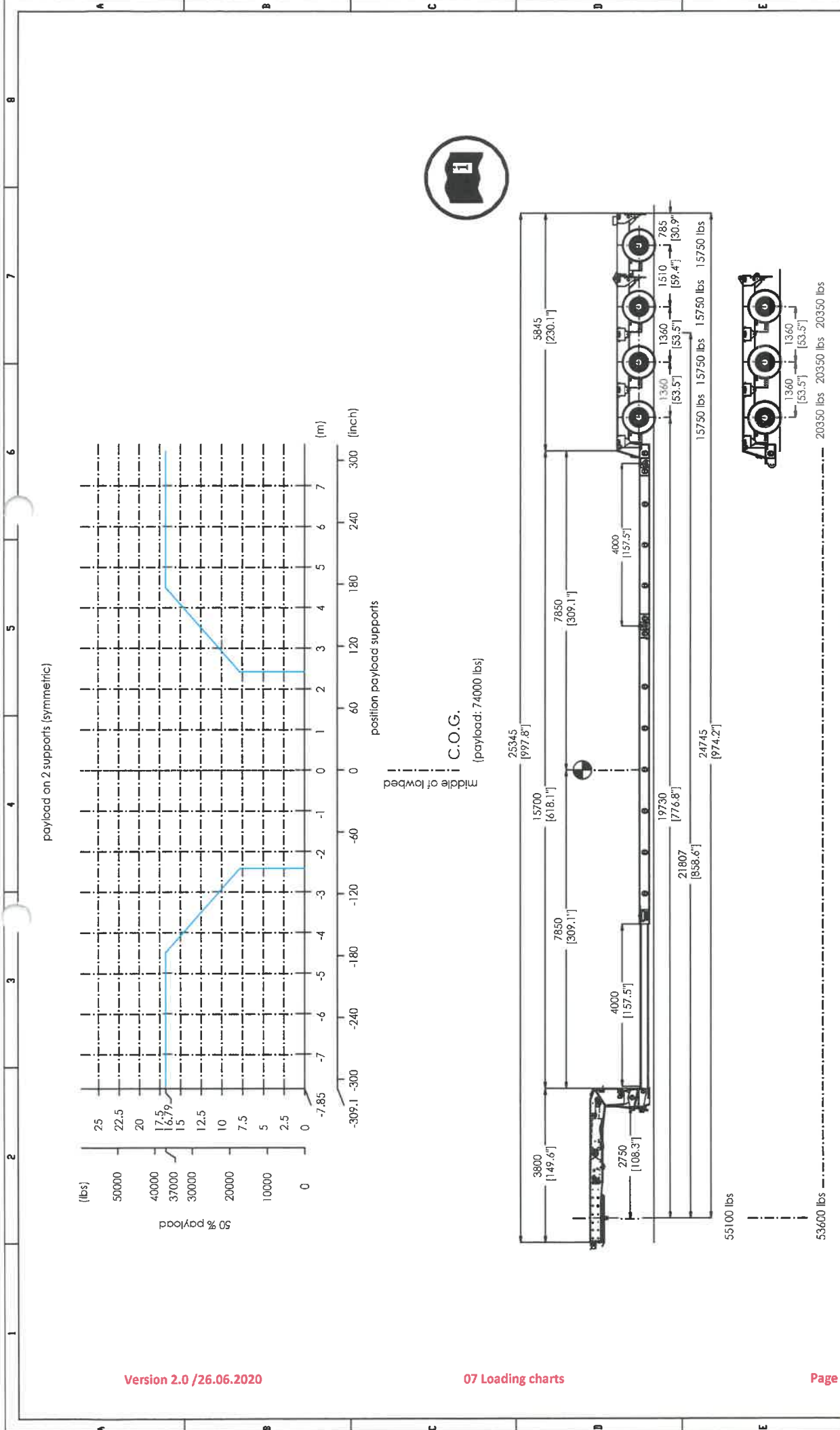

**Load Chart**  
 Mega-Z-4(3+)-L-KBX-A-30AT-7.70-17.5-2.54-(US)  
 Faymonville Distribution AG  
 Duarelsrooss 8  
 L-9990 Weiswampach  
 Tel.: +352 / 26 90 04 155  
 Fax.: +352 / 26 90 04 425  
 E-Mail : general@faymonville.com  
 Web : www.faymonville.com

Zeichnung: WWP\_TBF-009648(17) Rev.:

Datum	Name	1:85	A3
gez. 17.01.19	BSC		
gepr.			

Caution : the load chart does not take the deflection of the lowbed into account.  
 The deflection of the lowbed has a direct impact on the ground clearance and on the axle compensation.

payload on 2 supports (symmetric)

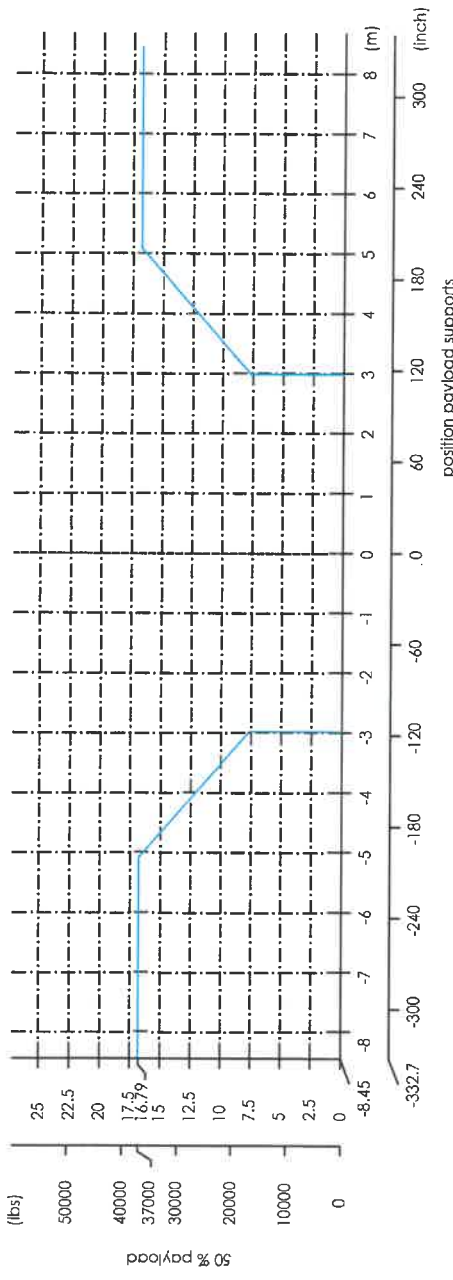

C.O.G.  
(payload: 74000 lbs)

middle of lowbed

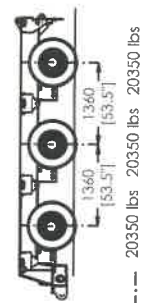
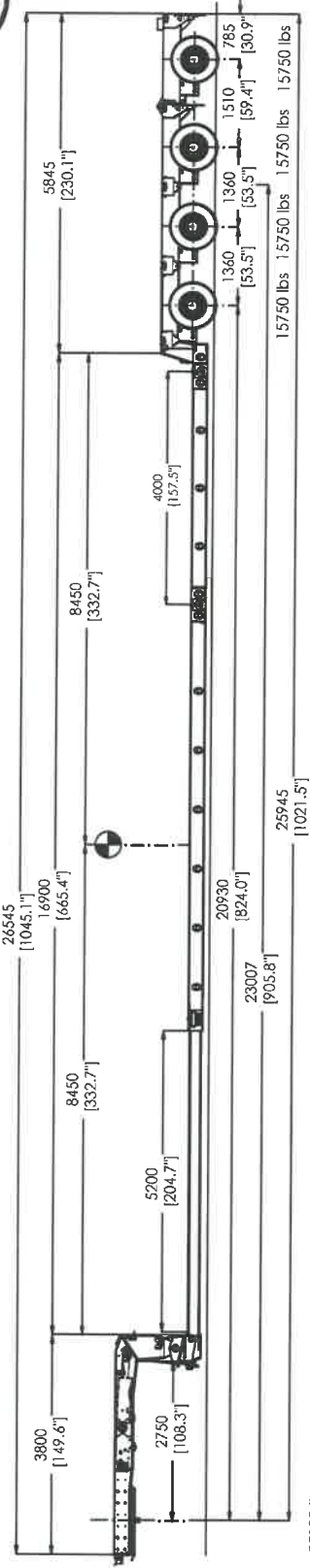

Zeichnung: WWP\_TBF-009648(18) Rev.:-

Datum	Name	1:85	A3
gez. 17.01.19	BSC		
gepr.			

**Load Chart**  
 Mega-Z-4(3+1)-V-KBX-A-30AT-7.70-17.5-2.54-(US)  
 Faymonville Distribution AG  
 Duarretstroos 8  
 L-9990 Weiswampach  
 Tel.: +352 / 26 90 04 155  
 Fax.: +352 / 26 90 04 425  
 E-Mail : general@faymonville.com  
 Web : www.faymonville.com



Caution : the load chart does not take the deflection of the lowbed into account. The deflection of the lowbed has a direct impact on the ground clearance and on the axle compensation.

1 2 3 4 5 6 7 8

payload on 2 supports (symmetric)

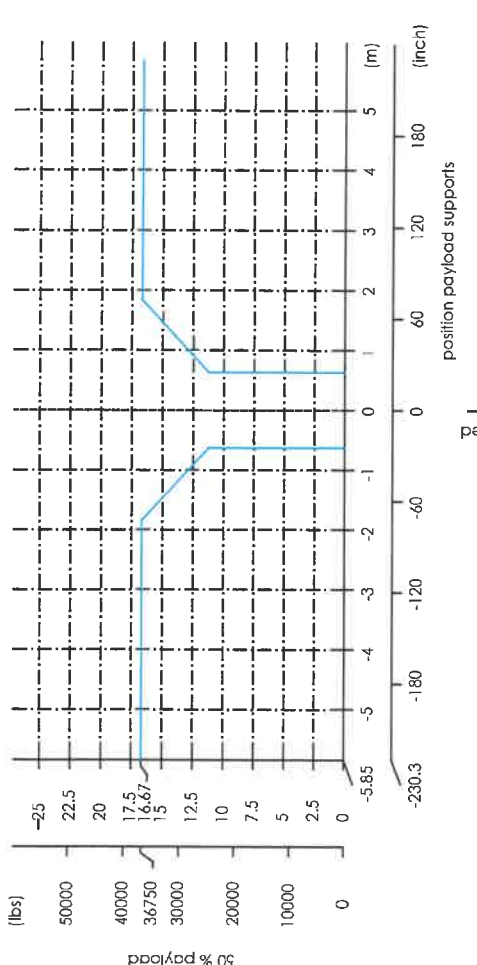

C.O.G.  
(payload: 73500 lbs)

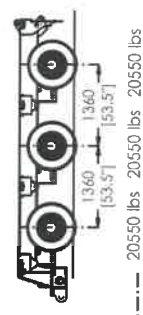
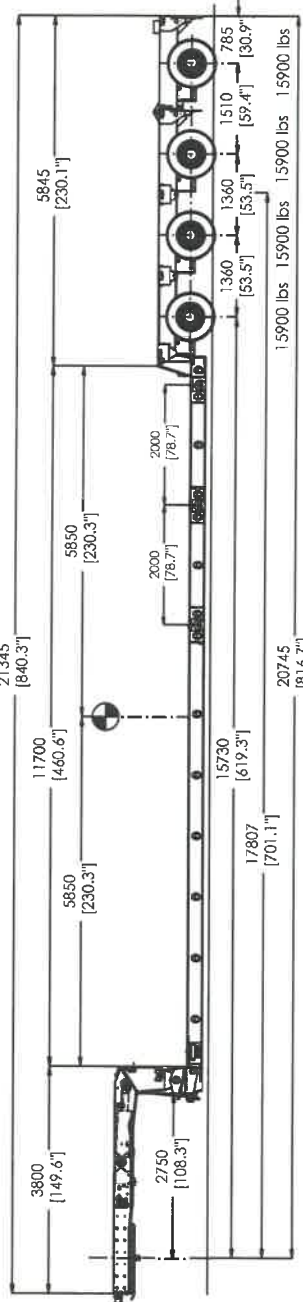

Zeichnung : WWP_TBF-009648(19)		Rev.:-
gez.	Datum	A3
gepr.	17.01.19	1.85
	Name	
	BSC	

**Load Chart**  
 Mega-Z-4(3+1)L-V-KBX-A-30A1-7-70-17-5-2.54-(US)  
 Faymonville Distribution AG  
 Duarretstroass 8  
 L-9990 Weiswampach  
 Tel.: +352 / 26 90 04 155  
 Fax.: +352 / 26 90 04 425  
 E-Mail : general@faymonville.com  
 Web : www.faymonville.com



Caution : the load chart does not take the deflection of the lowbed into account.  
 The deflection of the lowbed has a direct impact on the ground clearance and on the axle compensation.

payload on 2 supports (symmetric)

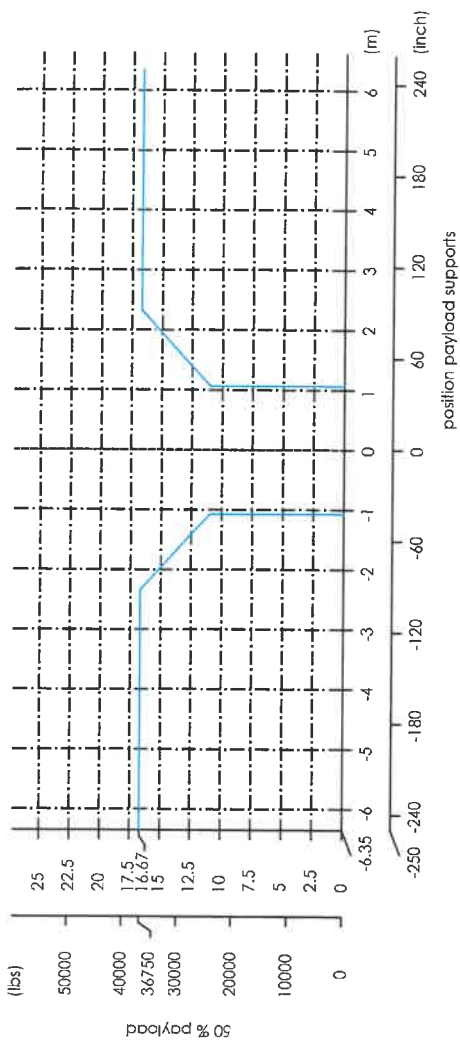

C.O.G.  
(payload: 73500 lbs)

Middle of lowbed

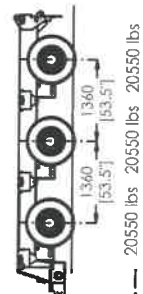
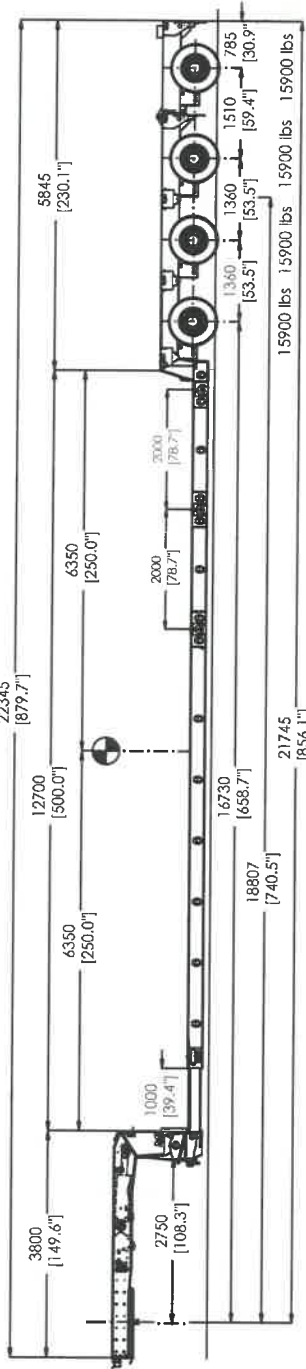

Zeichnung: WWP_TBF-009648(20)		Rev.:-	
Datum	Name	1:85	A3
gez. 17.01.19	BSC		
gepr.			

**Load Chart**  
 Mega-Z-4(3+1)-L-V-KBX-A-30A1-7.70-17.5-2.54-(US)  
 Faymonville Distribution AG  
 Duarrefstroos 8  
 L-9990 Weiswampach  
 Tel.: +352 / 26 90 04 155  
 Fax.: +352 / 26 90 04 425  
 E-Mail : general@faymonville.com  
 Web : www.faymonville.com



Caution : the load chart does not take the deflection of the lowbed into account. The deflection of the lowbed has a direct impact on the ground clearance and on the axle compensation.



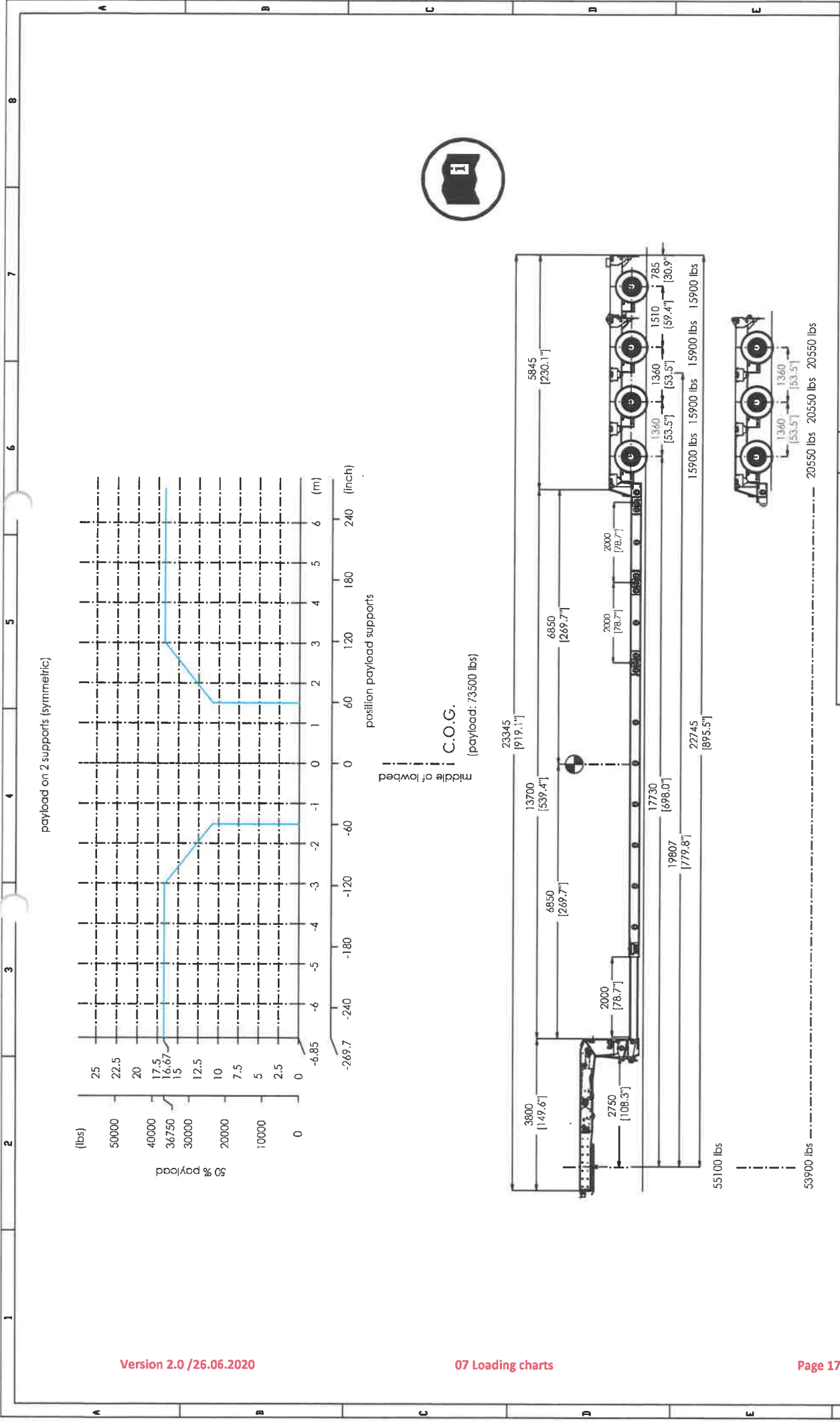

Version 2.0 /26.06.2020

07 Loading charts

Page 172 of 221

Zeichnung: WWP\_TBF-009648(21) Rev.: 1:85 A3

Datum	Name
17.01.19	BSC
gepr.	

**FAYMONVILLE**  
TRAILERS TO THE MAX

**Load Chart**  
 Mega-2-4(3+1)-L-V-KBX-A-30AT-7.70-17.5-2.54-(US)  
 Faymonville Distribution AG  
 Duarrefstroos 8  
 L-9990 Weiswampach  
 Tel.: +352 / 26 90 04 155  
 Fax.: +352 / 26 90 04 425  
 E-Mail : general@faymonville.com  
 Web : www.faymonville.com

Caution : the load chart does not take the deflection of the lowbed into account. The deflection of the lowbed has a direct impact on the ground clearance and on the axle compensation.

payload on 2 supports (symmetric)

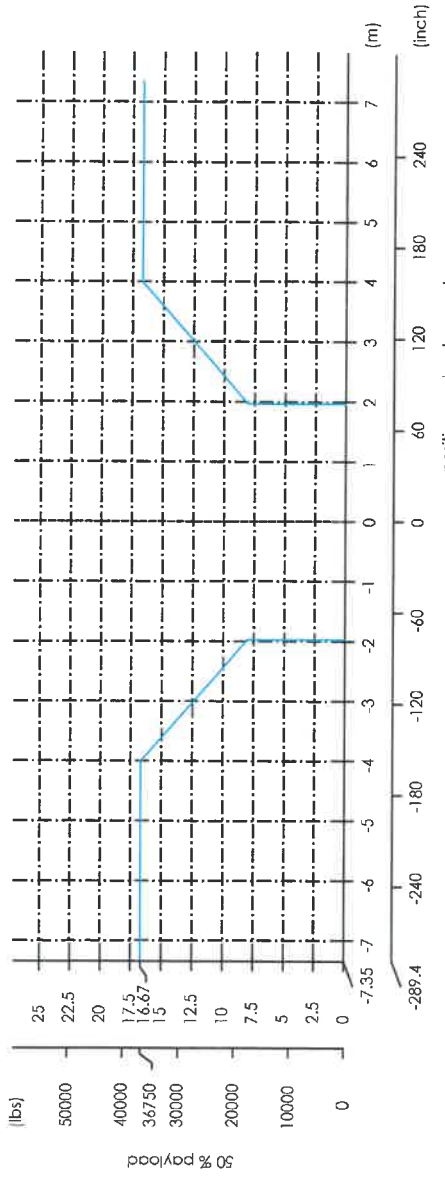

position payload supports

C.O.G.

(payload: 73500 lbs)

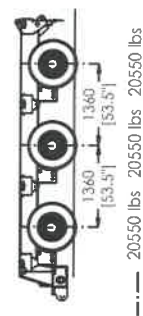
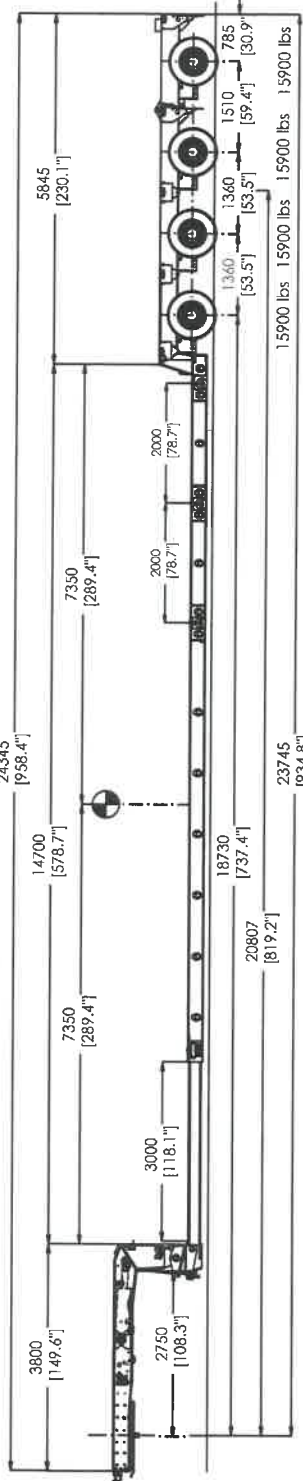

Zeichnung: WWP\_TBf-009648(22) Rev.: 1.85 A3

gez.	Datum	Name
gepl.	17.01.19	BSC

**Load Chart**  
 Mega-Z-4(3+1)-L-V-KBX-A-30A1-7-70-17.5-2.54-US  
 Faymonville Distribution AG  
 Duarretroos 8  
 L-9990 Weiswampach  
 Tel.: +352 / 26 90 04 155  
 Fax.: +352 / 26 90 04 425  
 E-Mail : general@faymonville.com  
 Web : www.faymonville.com



Caution : the load chart does not take the deflection of the lowbed into account. The deflection of the lowbed has a direct impact on the ground clearance and on the axle compensation.

payload on 2 supports (symmetric)

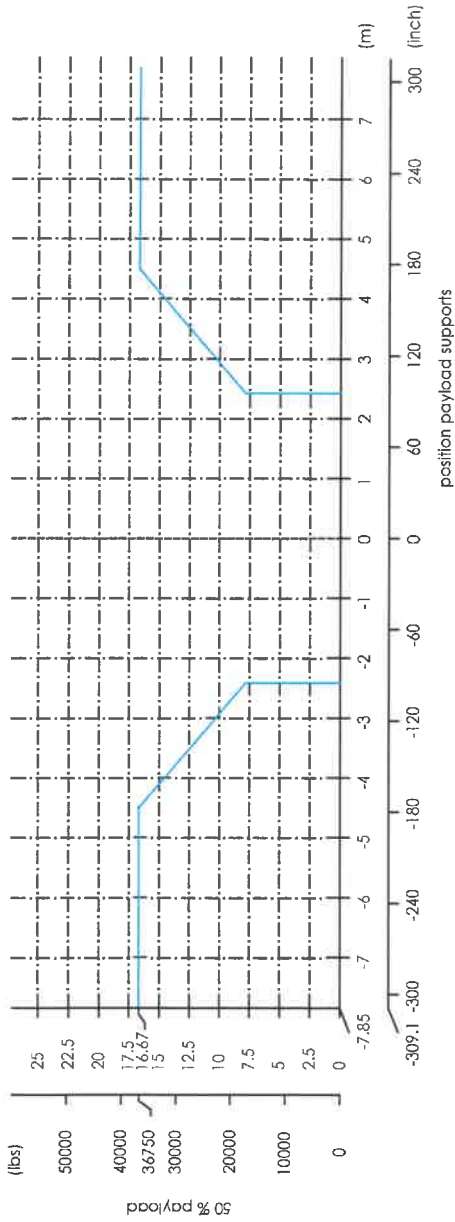

C.O.G.  
(payload: 73500 lbs)

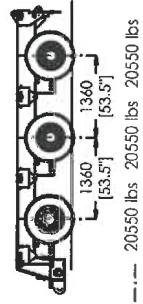
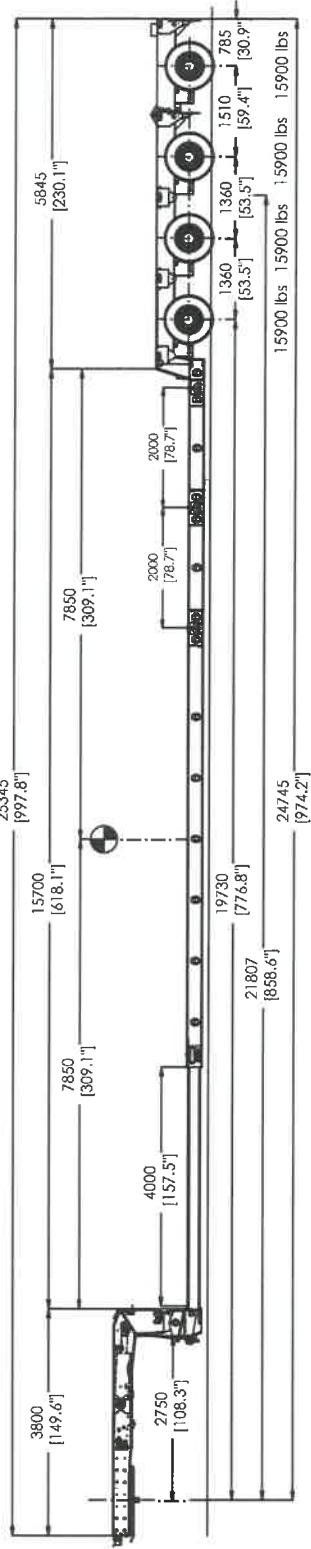

**Load Chart**  
 Mega-Z-4(3+1) L-V-KBX-A-30AT-7.70-17.5-2.54-(US)  
 Faymonville Distribution AG  
 Duarretstroos 8  
 L-9990 Weiswampach  
 Tel.: +352 / 26 90 04 155  
 Fax.: +352 / 26 90 04 425  
 E-Mail : general@faymonville.com  
 Web : www.faymonville.com

Zeichnung : WWP_TBF-009648(23)		Rev.:-	
Datum	Name	1:85	A3
gez. 17.01.19	BSC		
gepr.			



Caution : the load chart does not take the deflection of the lowbed into account.  
 The deflection of the lowbed has a direct impact on the ground clearance and on the axle compensation.

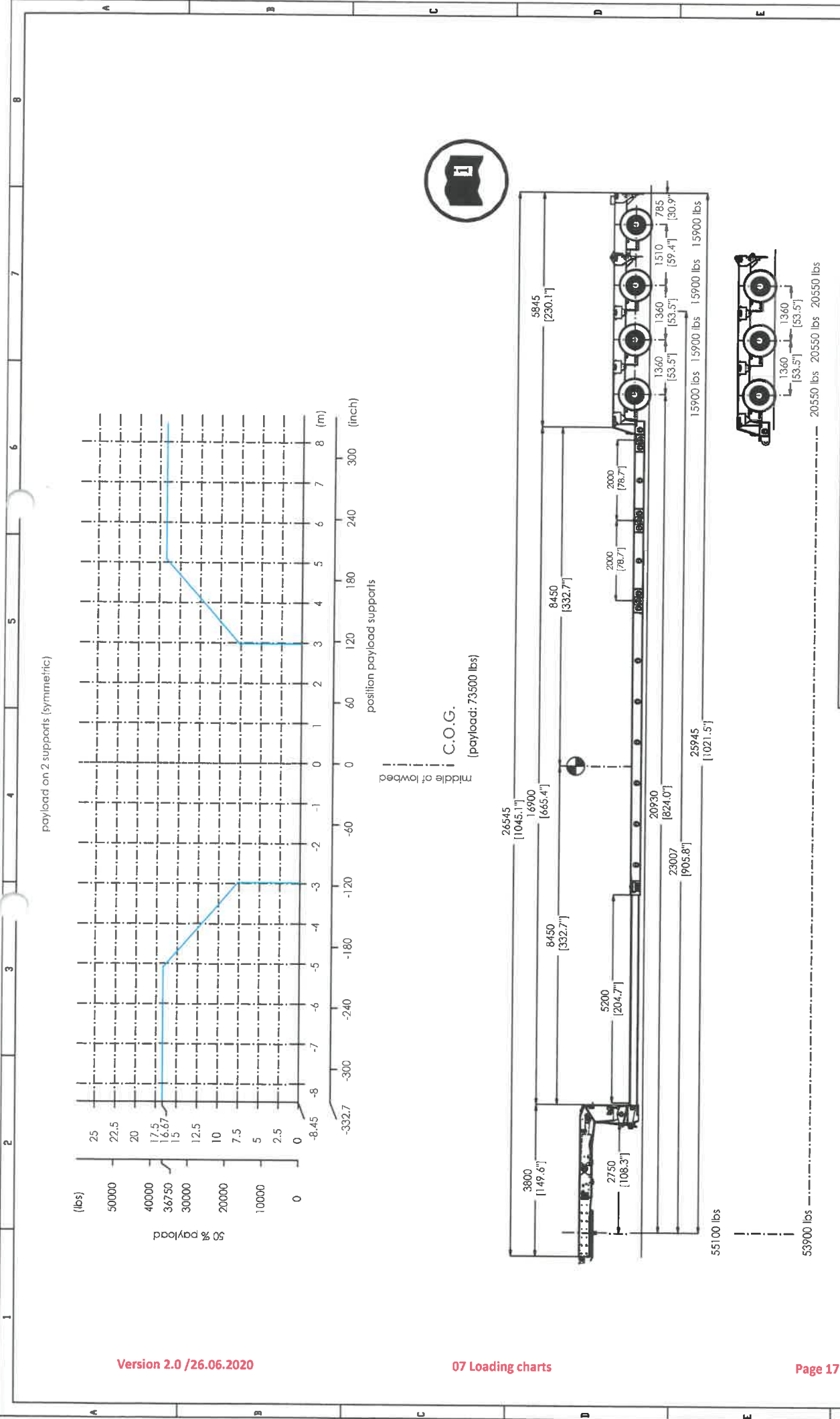

**Load Chart**  
 Mega-Z-4(3+)-L-V-KBX-A-30AT-7.70-17.5-2.54-(US)  
 Faymonville Distribution AG  
 Duarreisstrasse 8  
 L-9990 Weiswampach  
 Tel.: +352 / 26 90 04 155  
 Fax.: +352 / 26 90 04 425  
 E-Mail : general@faymonville.com  
 Web : www.faymonville.com

Zeichnung: WWP\_TBF-009648(24) Rev: -

gez.	Datum	Name	1:85	A3
gepr.	17.01.19	BSC		

**FAYMONVILLE**  
 TRAILERS TO THE MAX

Caution : the load chart does not take the deflection of the lowbed into account. The deflection of the lowbed has a direct impact on the ground clearance and on the axle compensation.

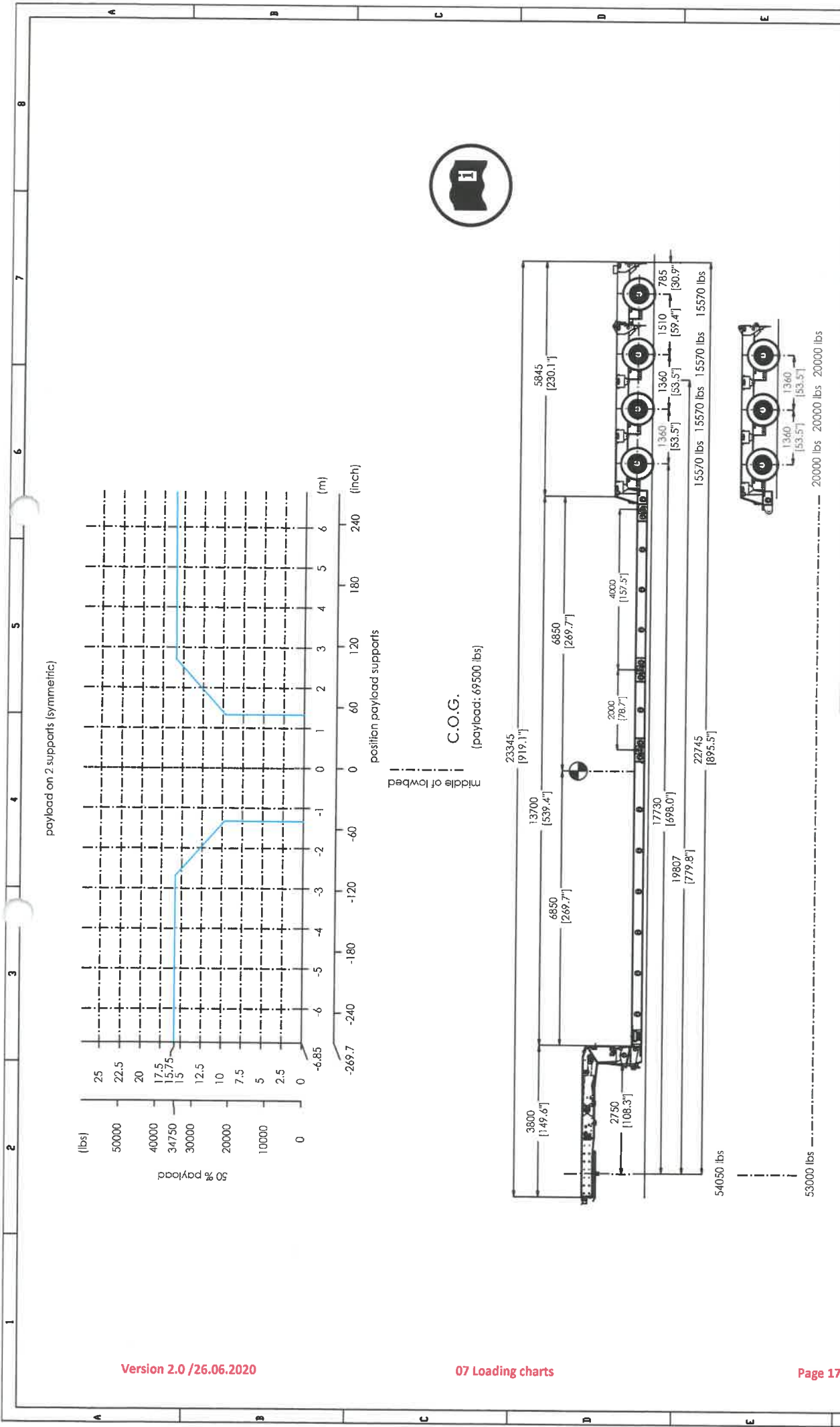

**Load Chart**  
 Mega-Z-4(3+1)L-V-KBX-A-30A1-7-70-17.5-2.54-(US)  
 Faymonville Distribution AG  
 Duareitstroos 8  
 L-9990 Weiswampach  
 Tel.: +352 / 26 90 04 155  
 Fax.: +352 / 26 90 04 425  
 E-Mail : general@faymonville.com  
 Web : www.faymonville.com

Zeichnung : WWP_TBF-009648(25)		Rev.:-	
Datum	Name	1:85	A3
gez. 17.01.19	BSC		
gepr.			



Caution : the load chart does not take the deflection of the lowbed into account. The deflection of the lowbed has a direct impact on the ground clearance and on the axle compensation.

payload on 2 supports (symmetric)

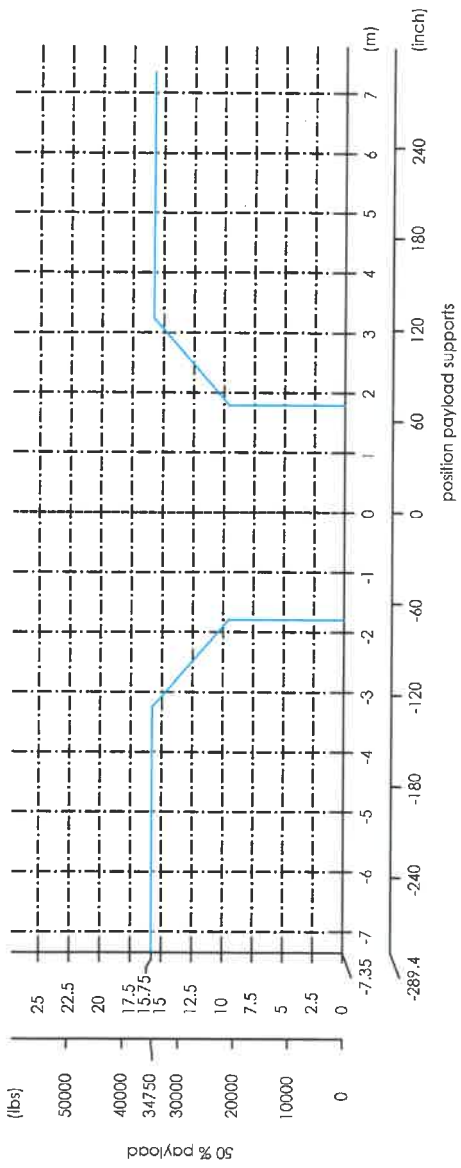

C.O.G.

(payload: 69500 lbs)

middle of lowbed

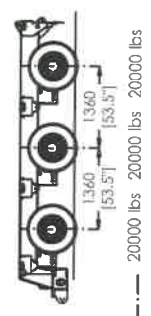
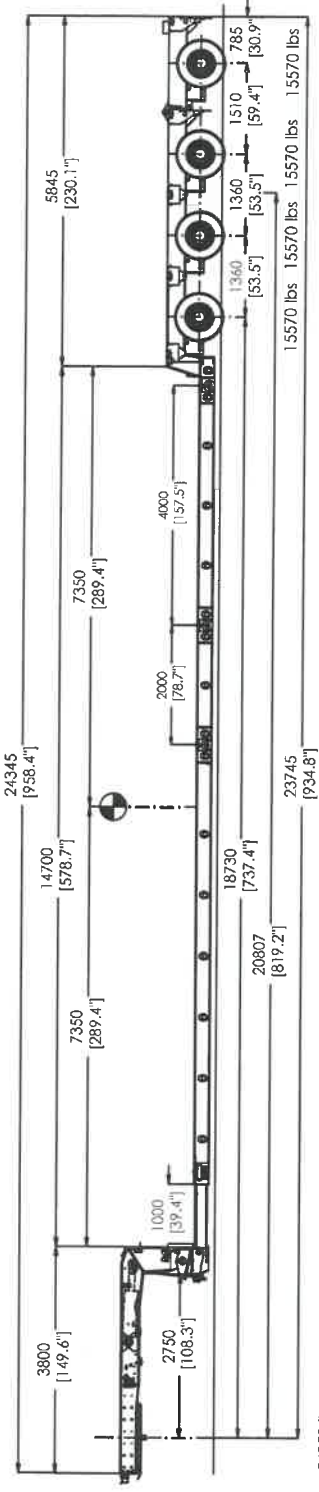

Zeichnung: WWP_TBF-009648(26)		Rev.:-
gez. 17.01.19	Name BSC	1.85 A3
gepr.		

Load Chart

Mega-Z-4(3+1)L-V-KBX-A-30AT-7.70-17.5-2.54-(US)

Faymonville Distribution AG  
 Duarretroos 8  
 L-9990 Weiswampach  
 Tel.: +352 / 26 90 04 155  
 Fax.: +352 / 26 90 04 425  
 E-Mail : general@faymonville.com  
 Web : www.faymonville.com



Caution : the load chart does not take the deflection of the lowbed into account.  
 The deflection of the lowbed has a direct impact on the ground clearance and on the axle compensation.

payload on 2 supports (symmetric)

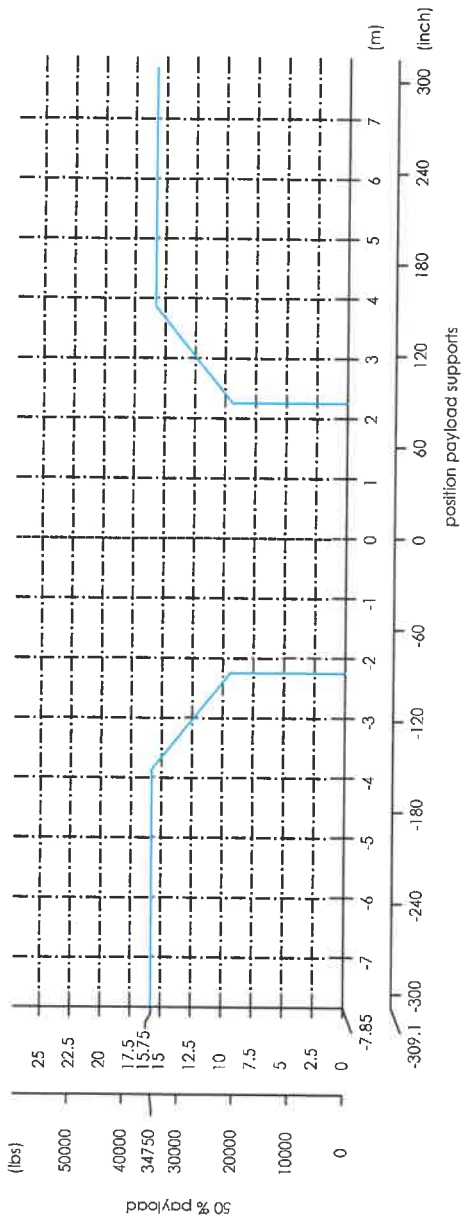

C.O.G.

(payload: 69500 lbs)

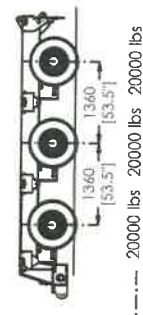
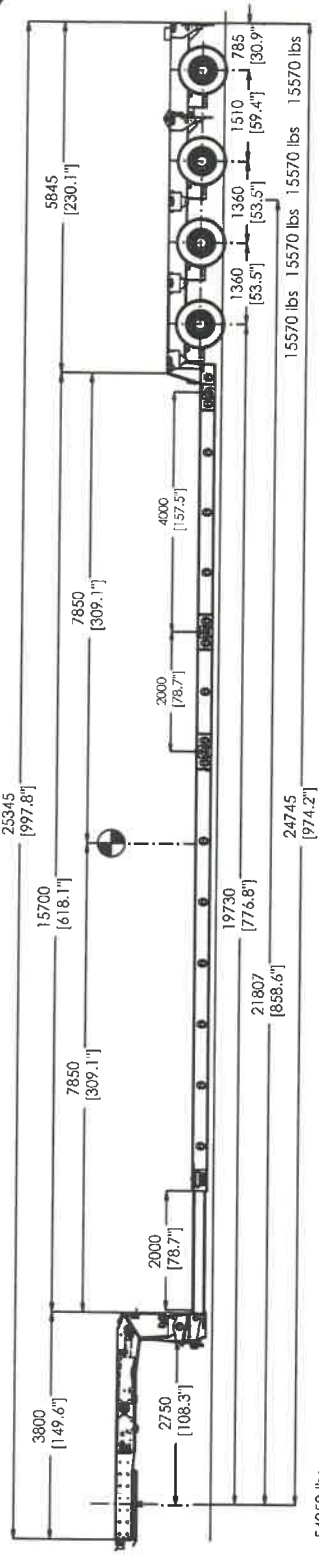

Zeichnung: WWP_TBF-009648(27)		Rev.: -	
gez.	17.01.19	Name	BSC
gepr.			
		1:85	A3

**Load Chart**  
 Mega-Z-4(3+1)-V-KBX-A-30AT-7.70-17.5-2.54-(US)  
 Faymonville Distribution AG  
 Duarrestroass 8  
 L-9990 Weiswampach  
 Tel.: +352 / 26 90 04 155  
 Fax.: +352 / 26 90 04 425  
 E-Mail: general@faymonville.com  
 Web: www.faymonville.com



Caution: the load chart does not take the deflection of the lowbed into account. The deflection of the lowbed has a direct impact on the ground clearance and on the axle compensation.

payload on 2 supports (symmetric)

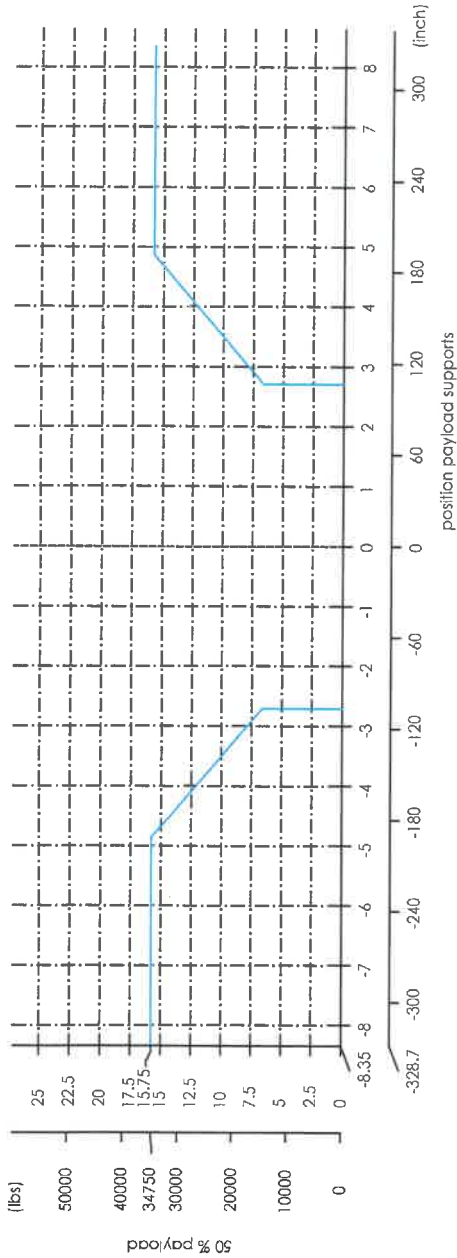

C.O.G.  
(payload: 69500 lbs)

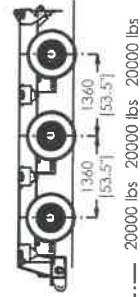
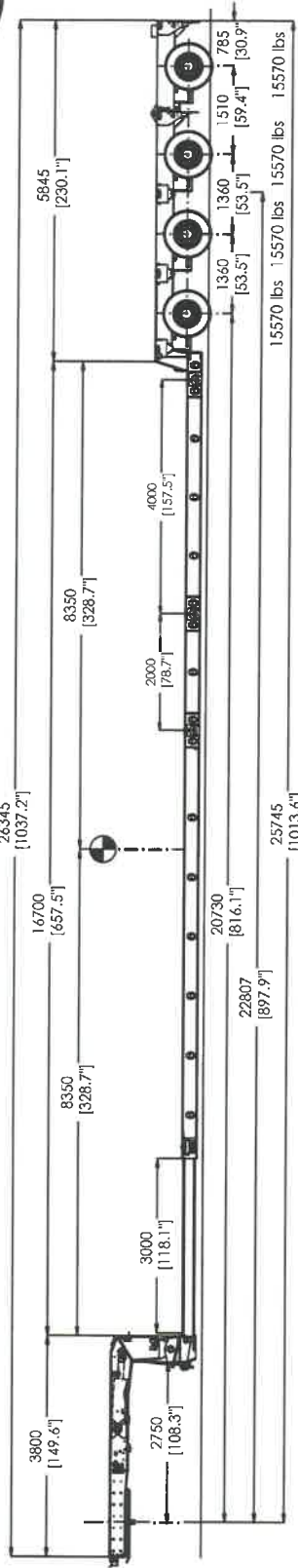

Zeichnung: WWP_TBF-009648(28)		Rev.:-
gez. 17.01.19	Name BSC	1:85 A3
gepr.		

**Load Chart**  
 Mega-Z-4(3+1)L-V-KBX-A-30A1-7.70-17.5-2.54-(US)  
 Faymonville Distribution AG  
 Duarretstroos 8  
 L-9990 Weiswampach  
 Tel.: +352 / 26 90 04 155  
 Fax.: +352 / 26 90 04 425  
 E-Mail : general@faymonville.com  
 Web : www.faymonville.com



Caution : the load chart does not take the deflection of the lowbed into account. The deflection of the lowbed has a direct impact on the ground clearance and on the axle compensation.



payload on 2 supports (symmetric)

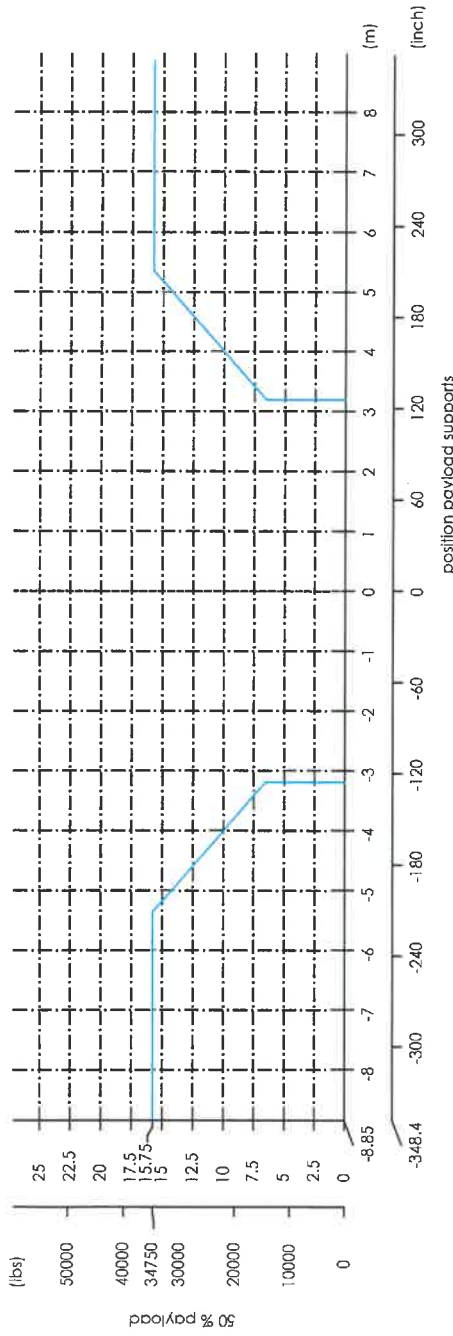

middle of lowbed  
C.O.G.  
(payload: 69500 lbs)

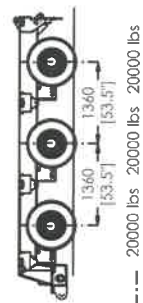
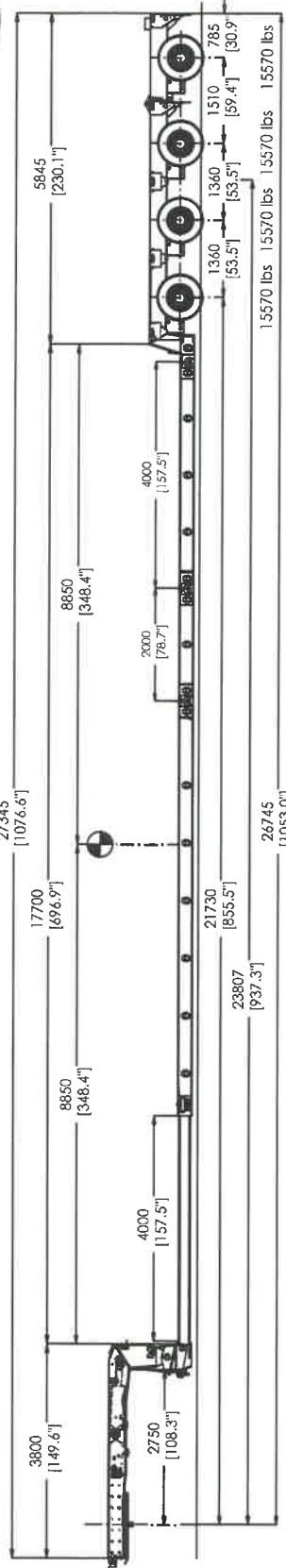

Zeichnung: WWP\_TBf-009.648(29) Rev.: A3

gez.	Datum	Name
gepl.	17.01.19	BSC

**Load Chart**  
 Mega-Z-4(3+1)-V-KBX-A-30AT-7.70-17.5-2.54-(US)  
 Faymonville Distribution AG  
 Duarretstroos 8  
 L-9990 Weiswampach  
 Tel.: +352 / 26 90 04 155  
 Fax.: +352 / 26 90 04 425  
 E-Mail : general@faymonville.com  
 Web : www.faymonville.com



Caution : the load chart does not take the deflection of the lowbed into account. The deflection of the lowbed has a direct impact on the ground clearance and on the axle compensation.

1 2 3 4 5 6 7 8

payload on 2 supports (symmetric)

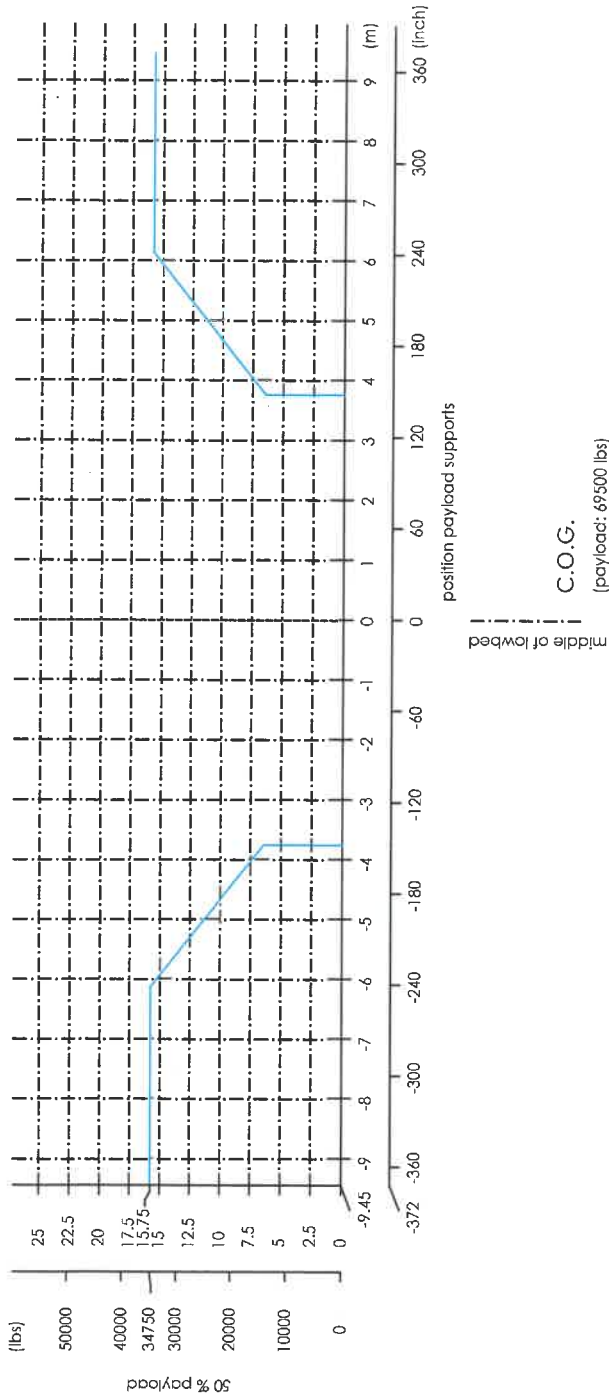

Version 2.0 /26.06.2020

07 Loading charts

Page 181 of 221

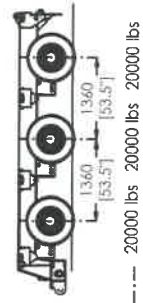
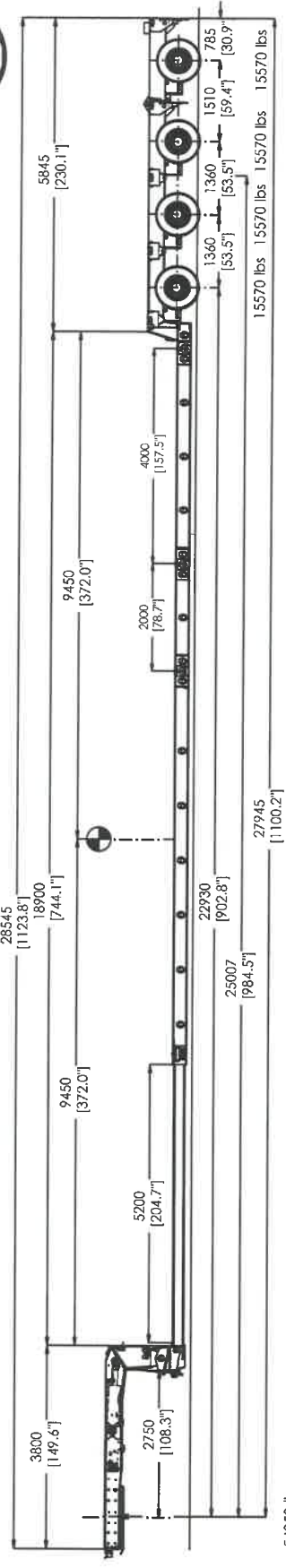

Zeichnung: WWP\_TBF-009648(30)

Load Chart  
Mega-Z-4(3+1)-V-KBX-A-30AT-7.70-17.5-2.54-(US)

Datum	Name	Rev.:-
gez. 17.01.19	8SC	1:85 A3
gepr.		

Faymonville Distribution AG  
Duarnestroos 8  
L-9990 Weiswampach  
Tel.: +352 / 26 90 04 155  
Fax.: +352 / 26 90 04 425  
E-Mail : general@faymonville.com  
Web : www.faymonville.com



Caution : the load chart does not take the deflection of the lowbed into account. The deflection of the lowbed has a direct impact on the ground clearance and on the axle compensation.

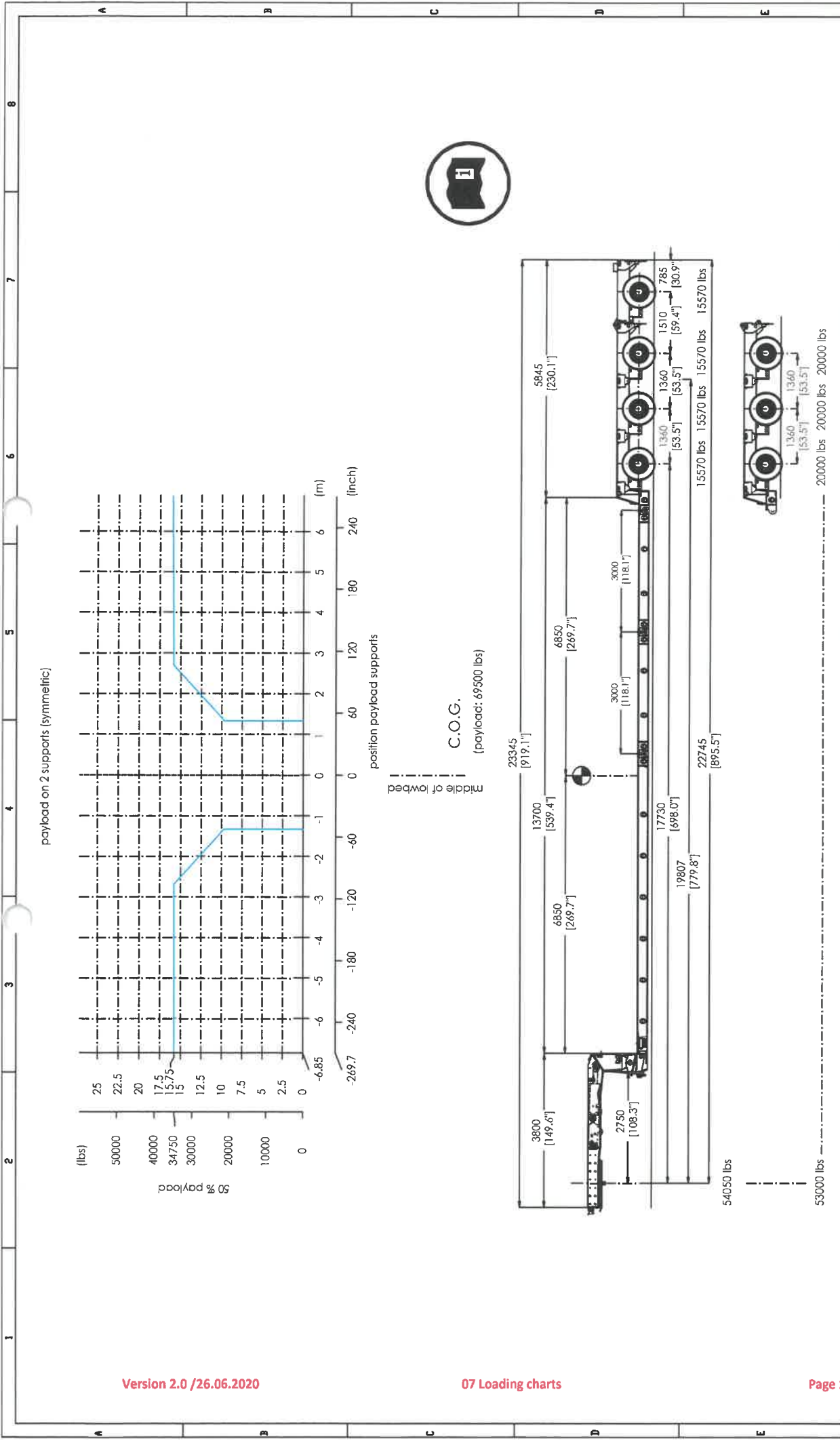

**Zeichnung:** WWP\_TBF-009648(31) Rev.:-

gez.	17.01.19	Datum	1:85	A3
gepr.		Name		

**Load Chart**  
 Mega-Z-4(3+)|L-V-KBX-A-30AT-7.70-17.5-2.54-(US)

Faymonville Distribution AG  
 Duarretroos 8  
 L-9990 Weiswampach  
 Tel.: +352 / 26 90 04 155  
 Fax.: +352 / 26 90 04 425  
 E-Mail: general@faymonville.com  
 Web: www.faymonville.com



Caution : the load chart does not take the deflection of the lowbed into account. The deflection of the lowbed has a direct impact on the ground clearance and on the axle compensation.

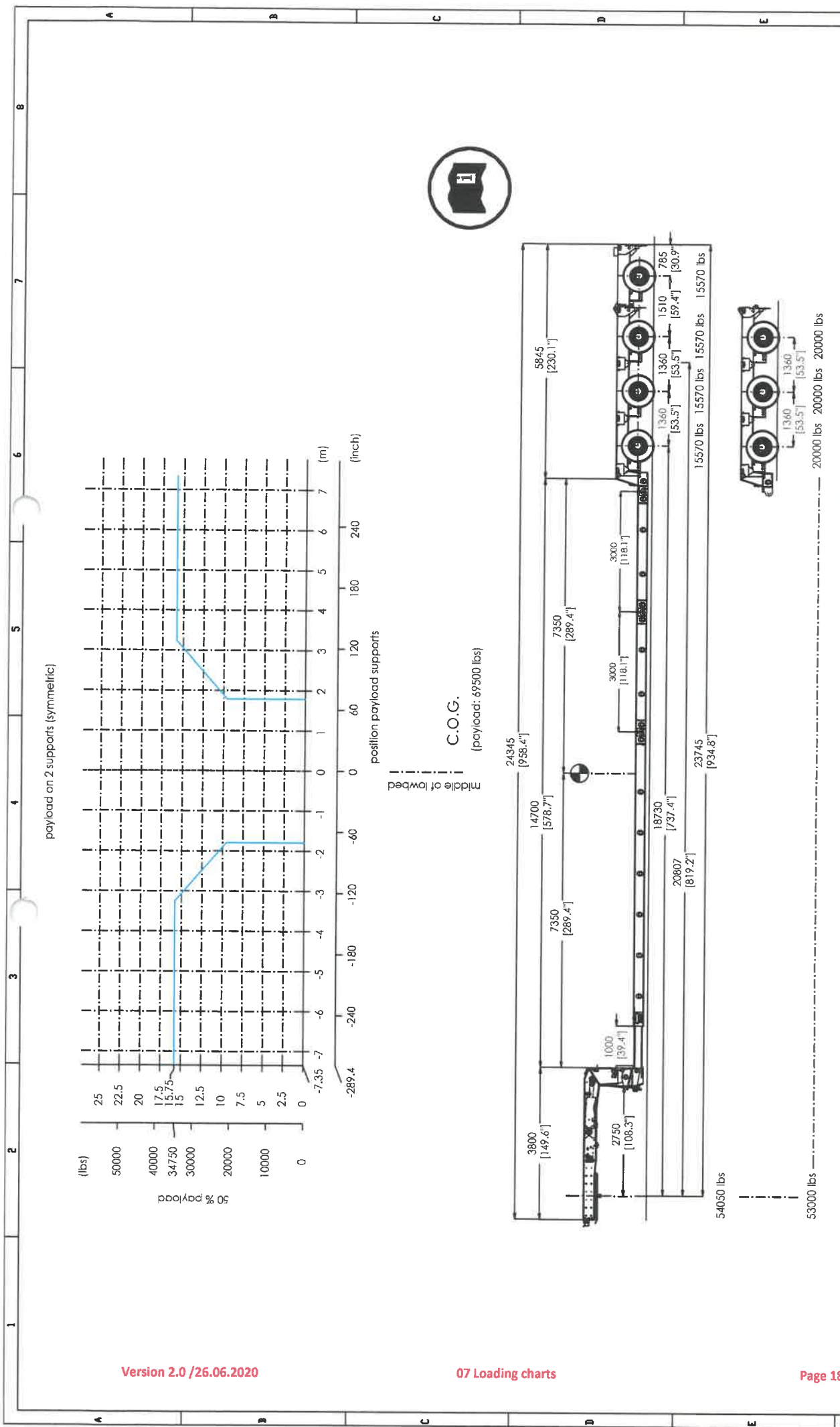

**Load Chart**

Mega-Z-4(3+)-L-V-KBX-A-30AT-7.70-17.5-2.54-(US)

Faymonville Distribution AG  
 Duarretroos 8  
 L-9990 Weiswampach  
 Tel.: +352 / 26 90 04 155  
 Fax.: +352 / 26 90 04 425  
 E-Mail: general@faymonville.com  
 Web: www.faymonville.com

Zeichnung: WWP_TBF-009648(32)		Rev.:-
gez.	17.01.19	1:85 A3
gepr.	BSC	
Datum	Name	



Caution: the load chart does not take the deflection of the lowbed into account. The deflection of the lowbed has a direct impact on the ground clearance and on the axle compensation.

payload on 2 supports (symmetric)

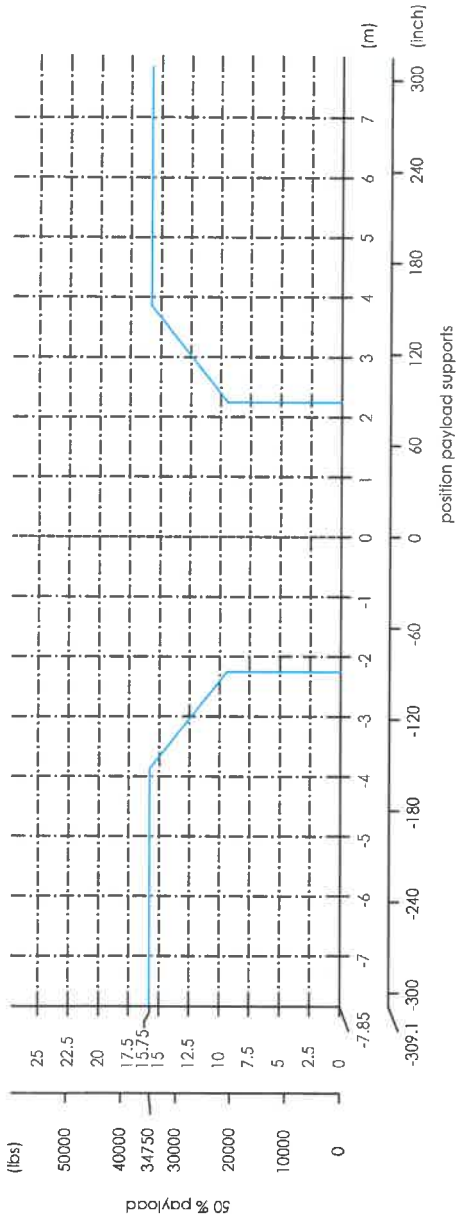

C.O.G.

(payload: 69500 lbs)

middle of lowbed

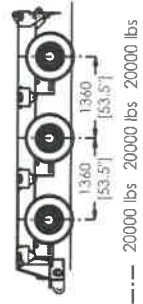
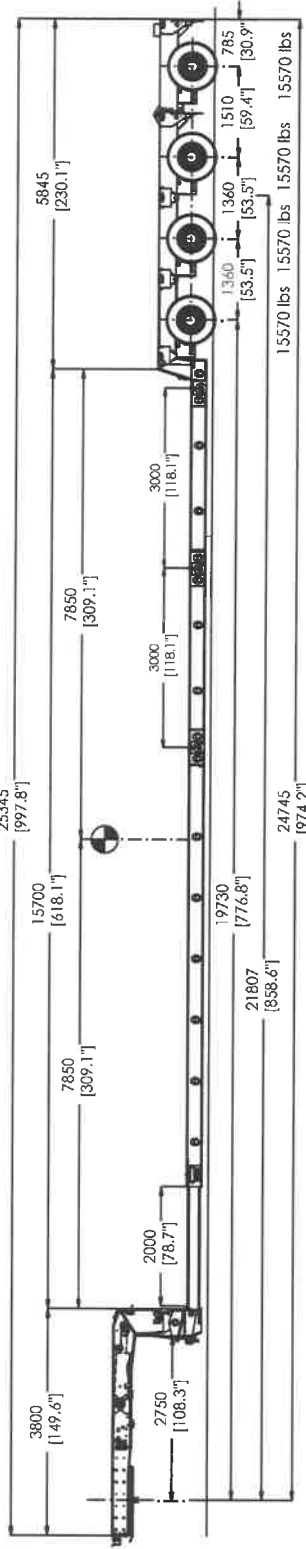

Zeichnung: WWP_TBF-009648(33)		Rev.:-
gez. 17.01.19	Name BSC	1:85 A3
gepr.		

**Load Chart**  
 Mega-Z-4(3+1)-V-KBX-A-30AT-7.70-17.5-2.54-US  
 Faymonville Distribution AG  
 Duarretroos 8  
 L-9990 Weiswampach  
 Tel.: +352 / 26 90 04 155  
 Fax.: +352 / 26 90 04 425  
 E-Mail: general@faymonville.com  
 Web: www.faymonville.com



Caution : the load chart does not take the deflection of the lowbed into account. The deflection of the lowbed has a direct impact on the ground clearance and on the axle compensation.

1 2 3 4 5 6 7 8

payload on 2 supports (symmetric)

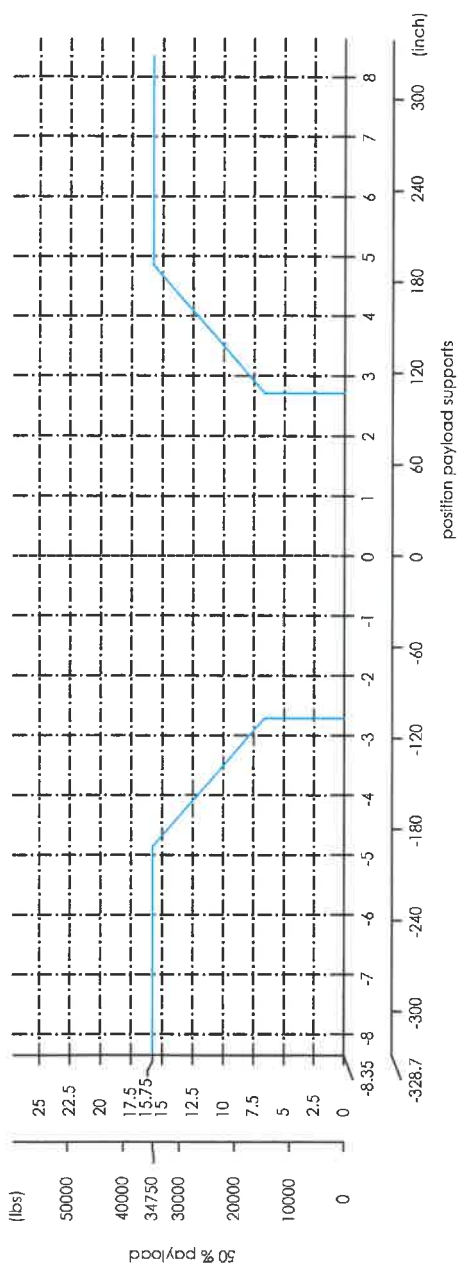

C.O.G.  
(payload: 69500 lbs)

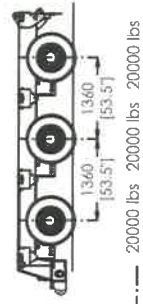
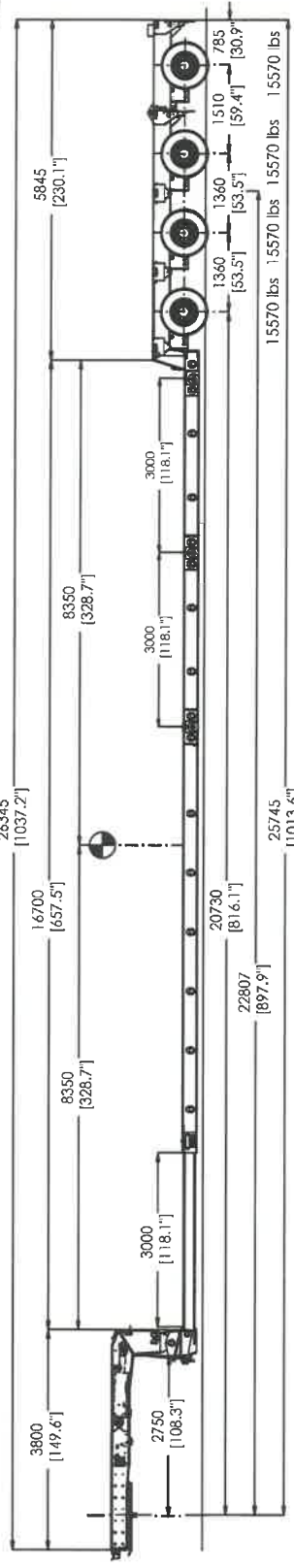

Zeichnung: WWP\_TBF-009648(34) Rev.: A3

Datum	Name
gez. 17.01.19	BSC
gepr.	

**Load Chart**  
 Mega-Z-4(3+)|L-V-KBX-A-30A|7.70-17.5-2.54-(US)  
 Faymonville Distribution AG  
 Duarrestroos 8  
 L-9990 Weiswampoch  
 Tel.: +352 / 26 90 04 155  
 Fax.: +352 / 26 90 04 425  
 E-Mail : general@faymonville.com  
 Web : www.faymonville.com



Caution : the load chart does not take the deflection of the lowbed into account. The deflection of the lowbed has a direct impact on the ground clearance and on the axle compensation.

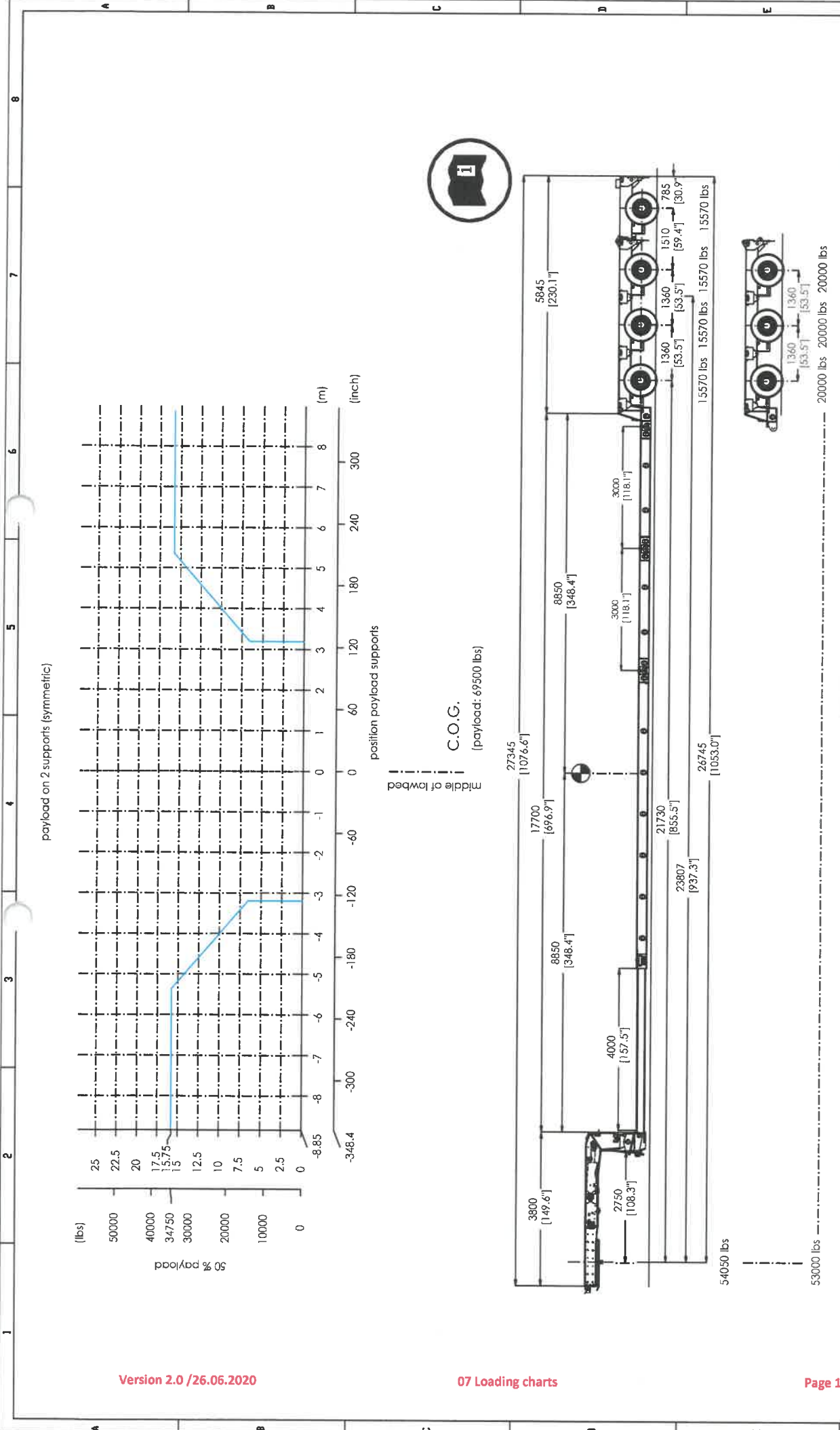

Version 2.0 / 26.06.2020

07 Loading charts

Page 186 of 221

### Load Chart

Mega-Z-4(3+1) L-V-KBX-A-30AT-7-70-17-5-2-54-(US)

Faymonville Distribution AG  
 Duarretroos 8  
 L-9990 Weiswampach  
 Tel.: +352 / 26 90 04 155  
 Fax.: +352 / 26 90 04 425  
 E-Mail : general@faymonville.com  
 Web : www.faymonville.com

Zeichnung : WWP_IBF-009648(35)		Rev.:-	
gezt.	17.01.19	Name	1:85 A3
gepr.			



Caution : the load chart does not take the deflection of the lowbed into account. The deflection of the lowbed has a direct impact on the ground clearance and on the axle compensation.

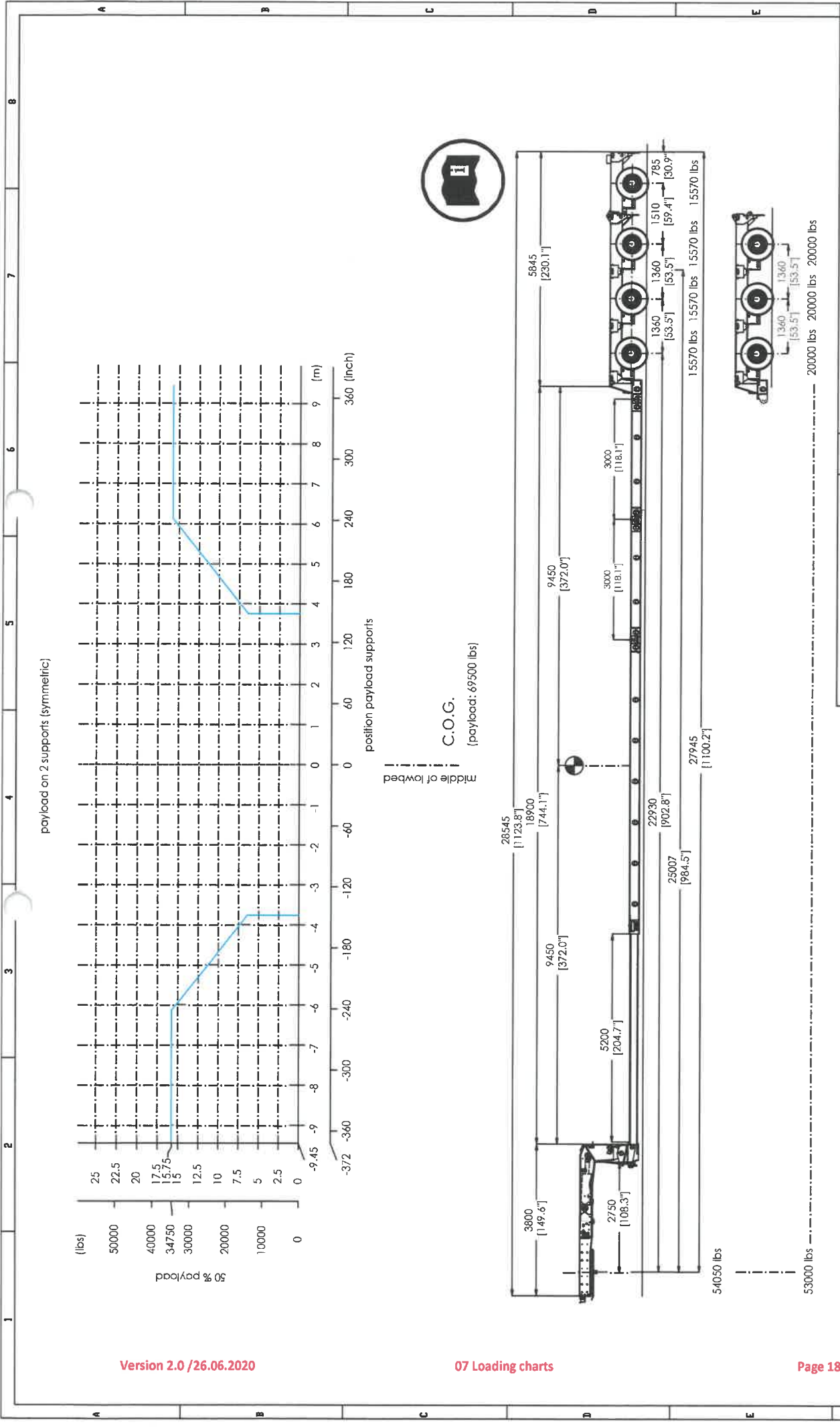

**Load Chart**

Mega-Z-4(3+1)-V-KBX-A-30A1-7.70-17.5-2.54-(US)

Faymonville Distribution AG  
 Duatretstroos 8  
 L-9990 Weiswampach  
 Tel.: +352 / 26 90 04 155  
 Fax.: +352 / 26 90 04 425  
 E-Mail : general@faymonville.com  
 Web : www.faymonville.com

Zeichnung : WWP_TBF-009648(36)		Rev.:-	
gez.	Datum	Name	1:85 A3
gepr.	17.01.19	BSC	



Caution : the load chart does not take the deflection of the lowbed into account. The deflection of the lowbed has a direct impact on the ground clearance and on the axle compensation.



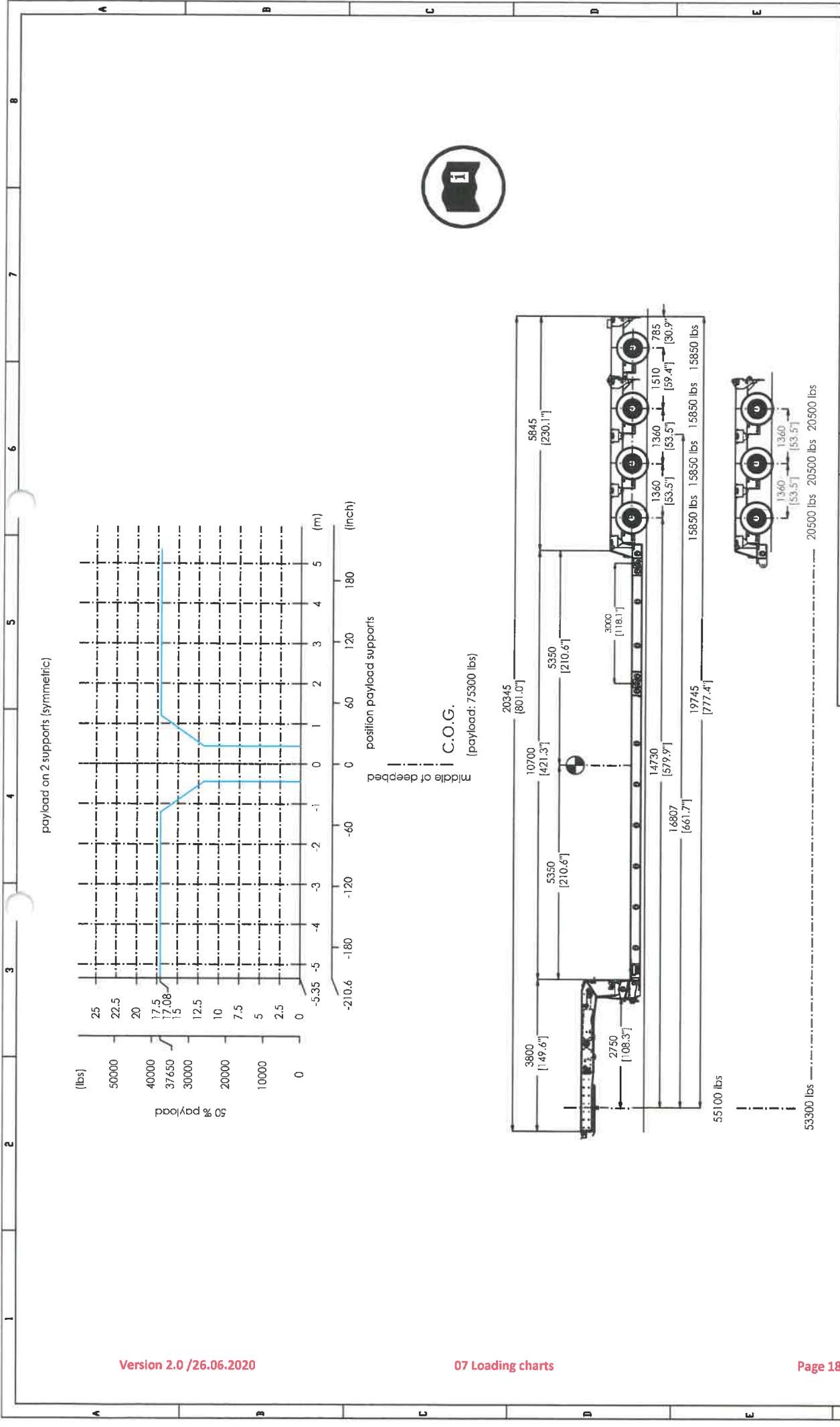

**Load Chart**

Mega-Z-4(3+1)L-V-KBX-A-30AT-7.70-17.5-2.54-(US)

Faymonville Distribution AG  
 Duarretroos 8  
 L-9990 Weiswampach  
 Tel.: +352 / 26 90 04 155  
 Fax.: +352 / 26 90 04 425  
 E-Mail : general@faymonville.com  
 Web : www.faymonville.com

Zeichnung : WWP_TBF-009648(37)		Rev.:-	
Datum	Name	1.85	A3
gez. 17.01.19	BSC		
gepr.			



Caution : the load chart does not take the deflection of the lowbed into account.  
 The deflection of the lowbed has a direct impact on the ground clearance and on the axle compensation.

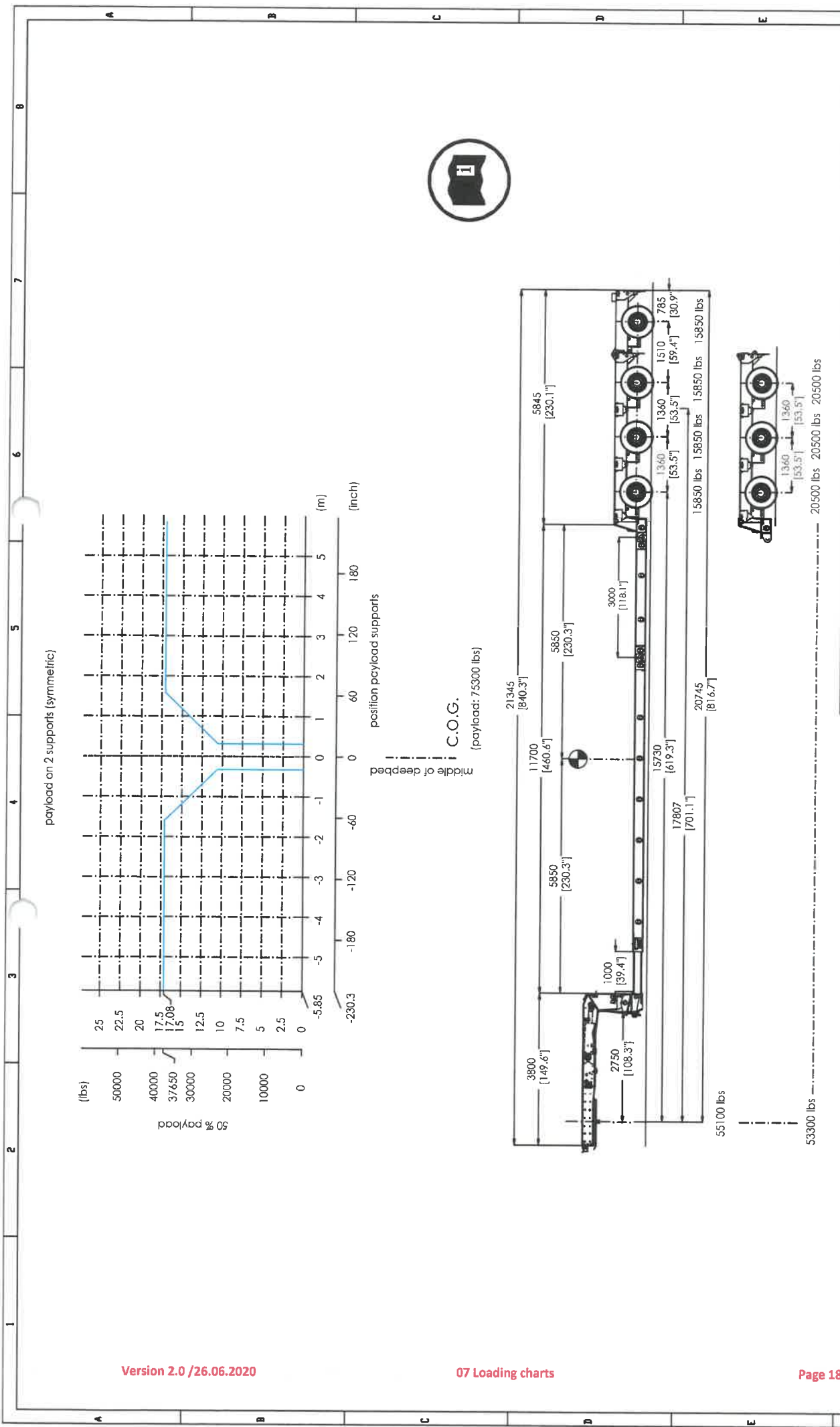

payload on 2 supports (symmetric)

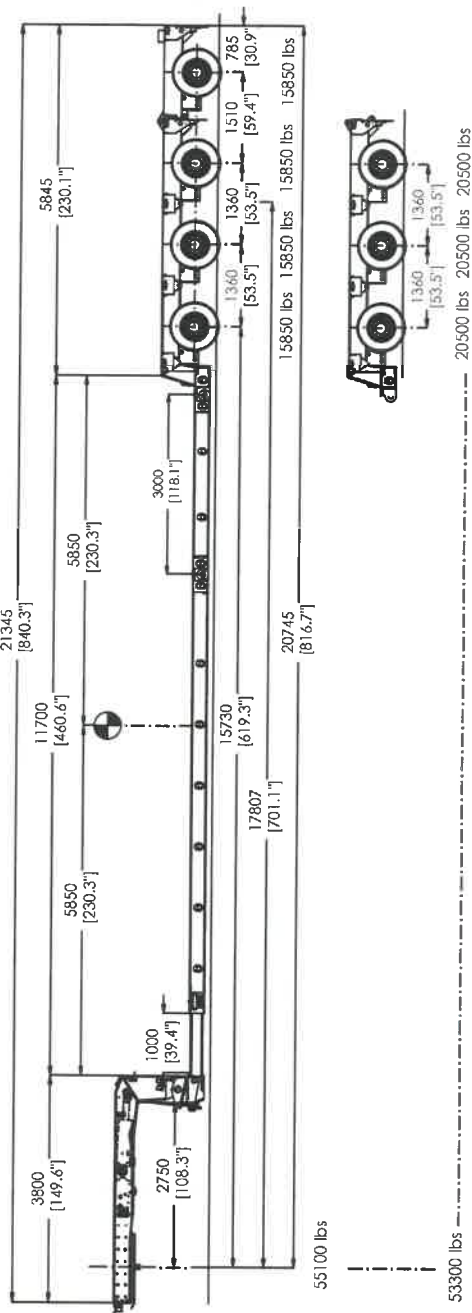
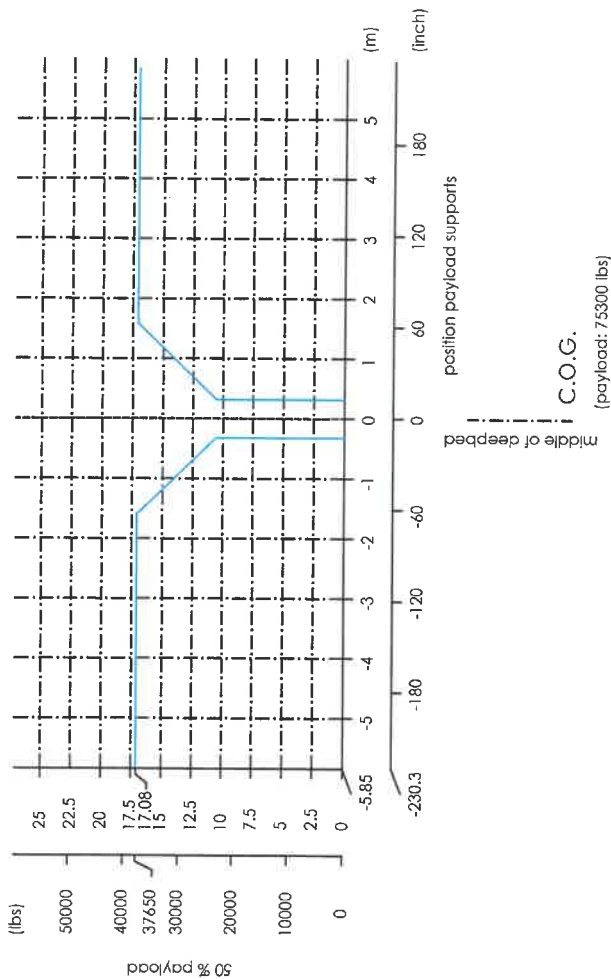

**Zeichnung:** WWP\_TBF-009648(38) **Rev.:-**

Datum	Name	1:85	A3
gez. 17.01.19	BSC		
gepr.			

**Load Chart**

Mega-Z-4(3+1)-V-KBX-A-30A1-7.70-17.5-2.54-(US)

Faymonville Distribution AG  
 Duarretstroos 8  
 L-9990 Weiswampach  
 Tel.: +352 / 26 90 04 155  
 Fax.: +352 / 26 90 04 425  
 E-Mail : general@faymonville.com  
 Web : www.faymonville.com

**FAYMONVILLE**  
TRAILERS TO THE MAX

Caution : the load chart does not take the deflection of the lowbed into account. The deflection of the lowbed has a direct impact on the ground clearance and on the axle compensation.

payload on 2 supports (symmetric)

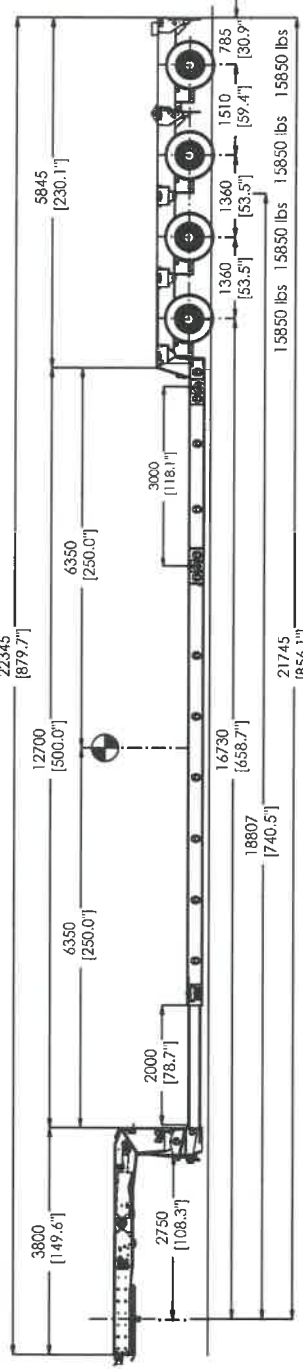
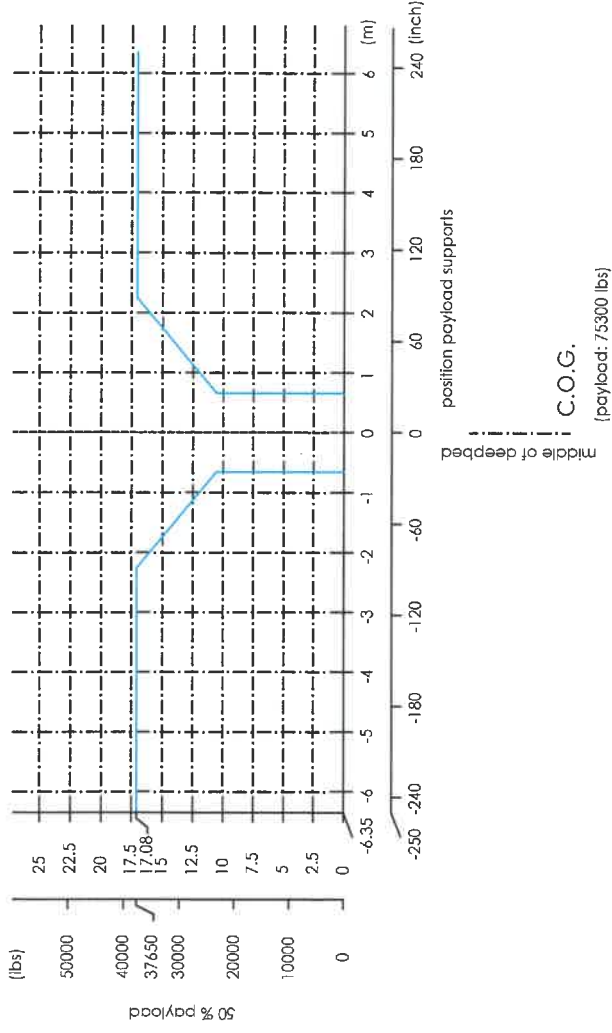

55100 lbs  
53300 lbs  
20500 lbs 20500 lbs

Zeichnung : WWP\_TBF-009648(39) Rev.:-

Datum	Name	Rev.
17.01.19	BSC	1:85 A3
gepr.		

**Load Chart**  
**Mega-Z-4(3+1)-V-KBX-A-30AT-7.70-17.5-2.54-(US)**  
 Faymonville Distribution AG  
 Duarretstroos 8  
 L-9990 Weiswampach  
 Tel.: +352 / 26 90 04 155  
 Fax.: +352 / 26 90 04 425  
 E-Mail : general@faymonville.com  
 Web : www.faymonville.com



Caution : the load chart does not take the deflection of the lowbed into account.  
 The deflection of the lowbed has a direct impact on the ground clearance and on the axle compensation.

payload on 2 supports (symmetric)

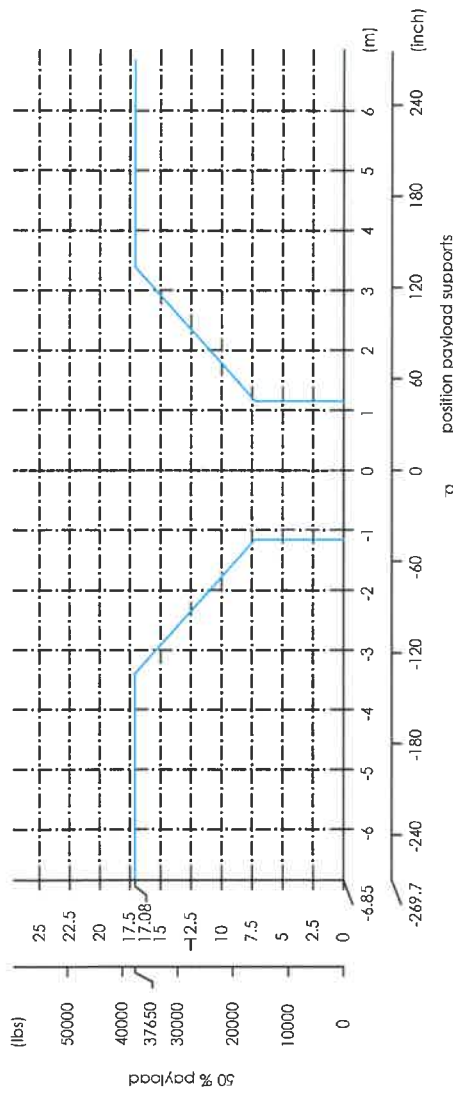

C.O.G.  
(payload: 75300 lbs)

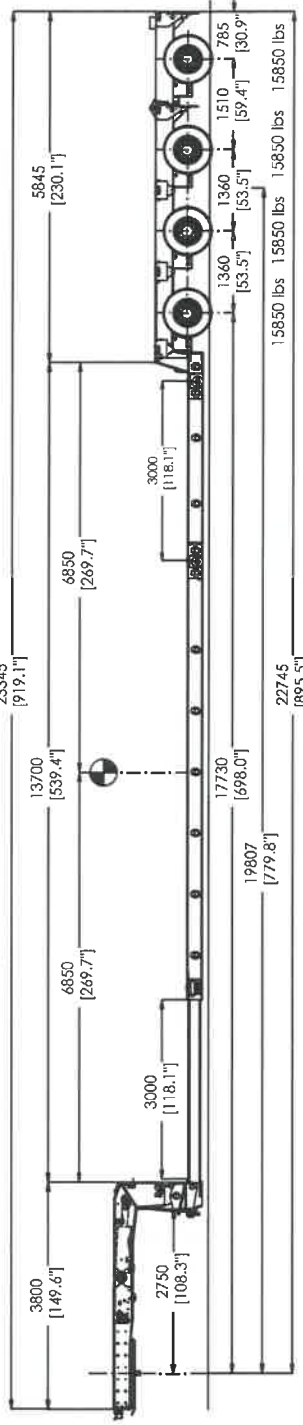

55100 lbs  
20500 lbs 20500 lbs 20500 lbs

**Load Chart**  
 Mega-Z-4(3+1) L-V-KBX-A-30AT-7.0-17.5-2.54-(US)

Faymonville Distribution AG  
 Duarrefstroos 8  
 L-9990 Weiswampach  
 Tel.: +352 / 26 90 04 155  
 Fax.: +352 / 26 90 04 425  
 E-Mail : general@faymonville.com  
 Web : www.faymonville.com

Zeichnung : WWP\_TBF-009648(40) Rev.: -

Datum	Name	Rev.
gez. 17.01.19	BSC	1:85 A3
gepr.		



Caution : the load chart does not take the deflection of the lowbed into account.  
 The deflection of the lowbed has a direct impact on the ground clearance and on the axle compensation.

payload on 2 supports (symmetric)

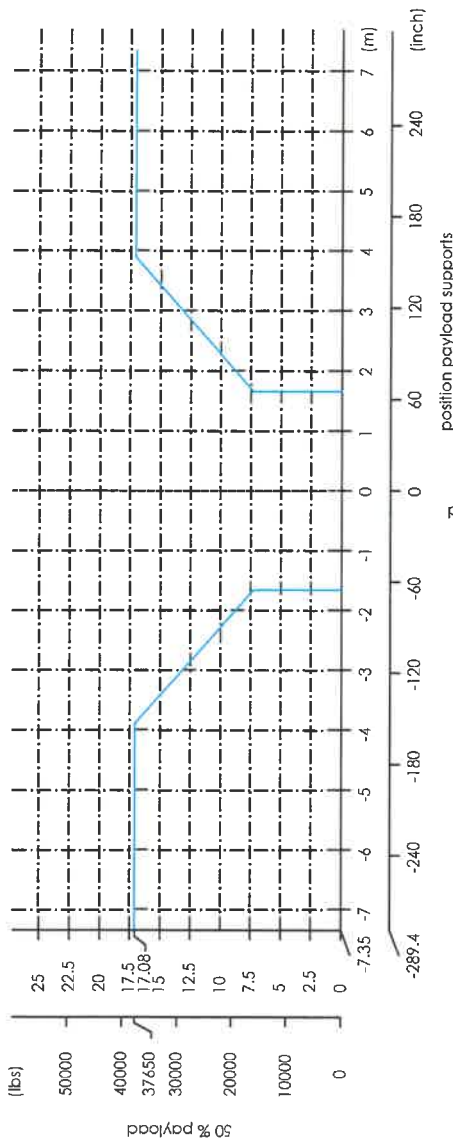

C.O.G.

(pay/load: 75300 lbs)

middle of deepbed

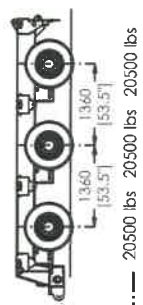
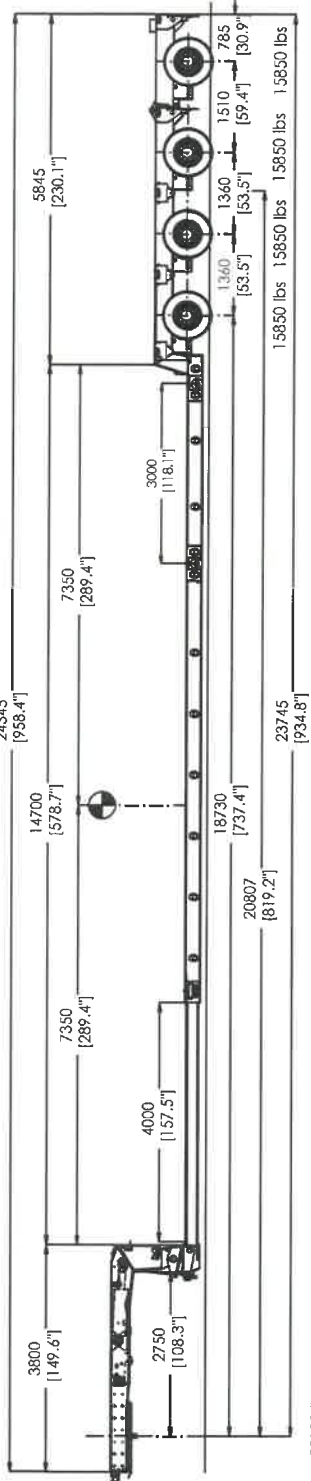

55100 lbs ——— 20500 lbs 20500 lbs 20500 lbs

Zeichnung : WWP_TBF-009648(41)		Rev.:-	
Datum	Name	1.85	A3
gez. 17.01.19	BSC		
gspr.			

**Load Chart**  
 Mega-Z-4(3+1)-V-KBX-A-30AT-7.70-17.5-2.54-(US)  
 Faymonville Distribution AG  
 Duarretroos 8  
 L-9990 Weiswampach  
 Tel.: +352 / 26 90 04 155  
 Fax.: +352 / 26 90 04 425  
 E-Mail : general@faymonville.com  
 Web : www.faymonville.com



Caution : the load chart does not take the deflection of the lowbed into account. The deflection of the lowbed has a direct impact on the ground clearance and on the axle compensation.

1 2 3 4 5 6 7 8

payload on 2 supports (symmetric)

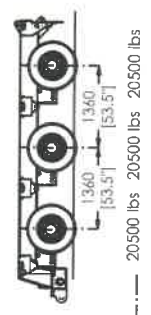
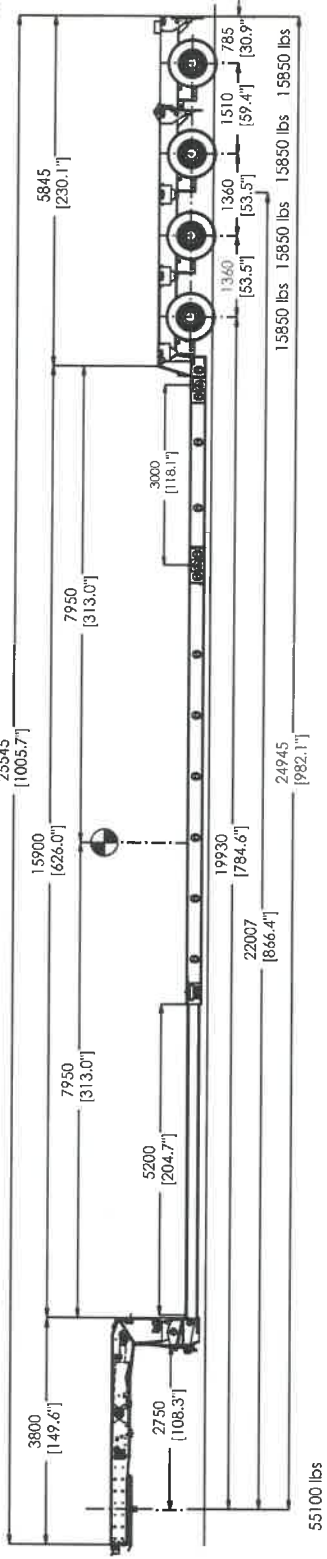
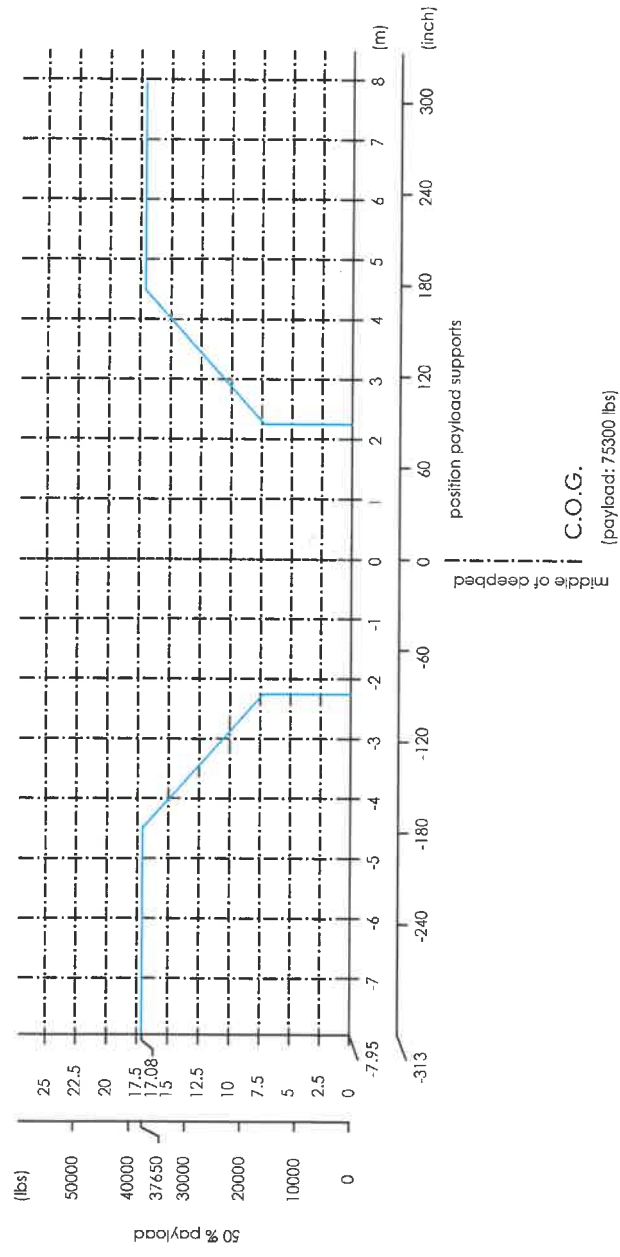

Zeichnung: WWP_TBF-009648(42)		Rev.:-	
Datum	Name	1.85	A3
gez. 17.01.19	BSC		
grpi.			

**Load Chart**  
 Mega-Z-4(3+1)L-V-KBX-A-30A1-7.70-17.5-2.54-(US)  
 Faymonville Distribution AG  
 Duarretroos 8  
 L-9990 Weiswampach  
 Tel.: +352 / 26 90 04 155  
 Fax.: +352 / 26 90 04 425  
 E-Mail : general@faymonville.com  
 Web : www.faymonville.com



Caution : the load chart does not take the deflection of the lowbed into account.  
 The deflection of the lowbed has a direct impact on the ground clearance and on the axle compensation.

1 2 3 4 5 6 7 8

payload on 2 supports (symmetric)

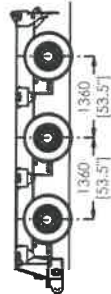
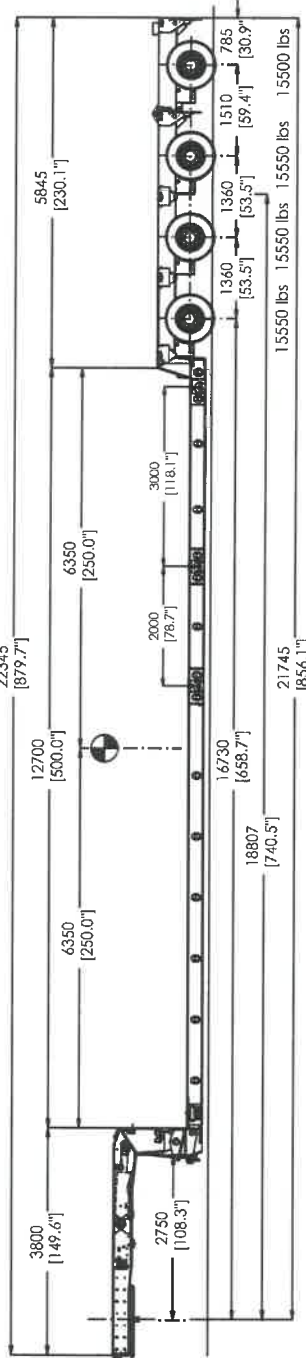
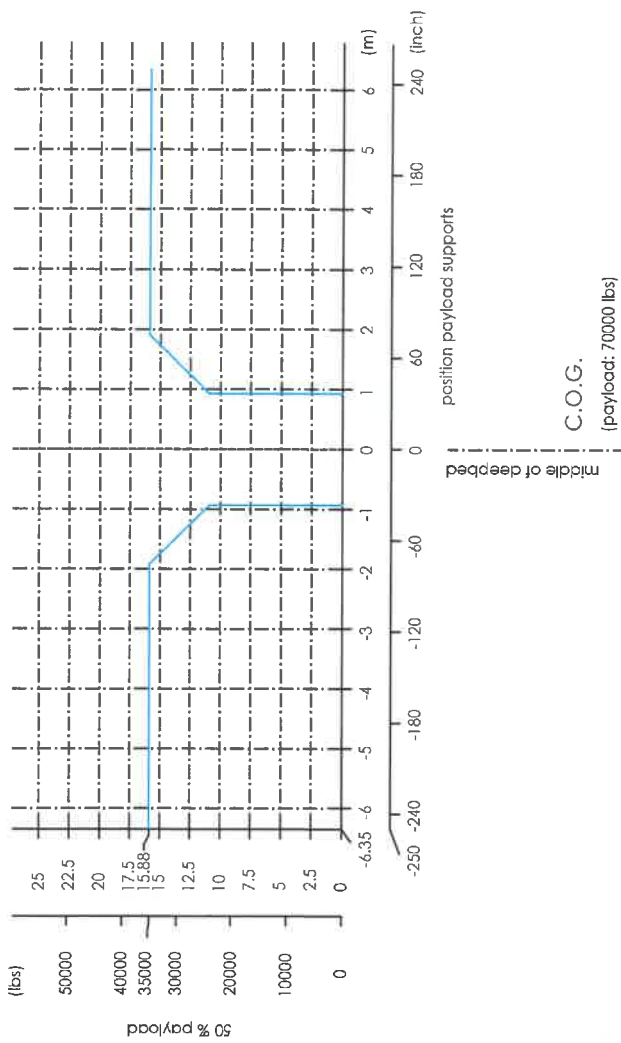

54200 lbs  
53000 lbs ——— 20000 lbs 20000 lbs 20000 lbs

Zeichnung : WWP\_TBf-009648(43) Rev.:-

Datum	Name	Rev.
gez. 17.01.19	BSC	1:85 A3
gepr.		

**Load Chart**  
 Mega-Z-4(3+1)-V-KBX-A-30AT-7.70-17.5-2.54-(US)  
 Faymonville Distribution AG  
 Duarretstrooss 8  
 L-9990 Weiswampach  
 Tel.: +352 / 26 90 04 155  
 Fax.: +352 / 26 90 04 425  
 E-Mail : general@faymonville.com  
 Web : www.faymonville.com



Caution : the load chart does not take the deflection of the lowbed into account. The deflection of the lowbed has a direct impact on the ground clearance and on the axle compensation.

1 2 3 4 5 6 7 8

1 2 3 4 5 6 7 8

payload on 2 supports [symmetric]

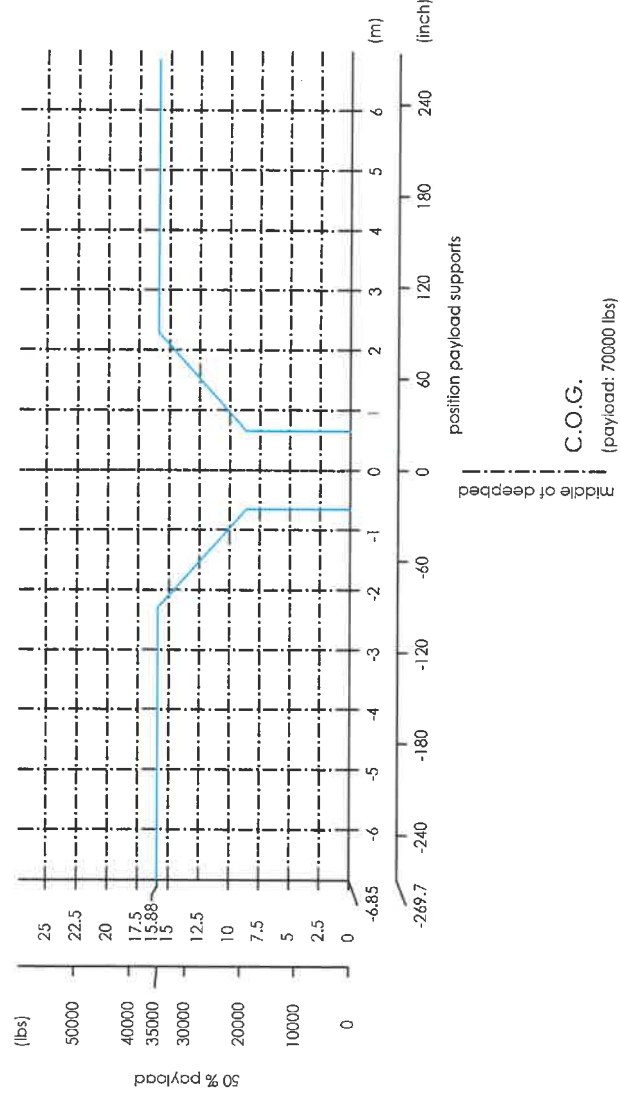

C.O.G.

(payload: 70000 lbs)

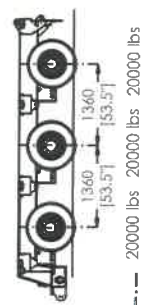
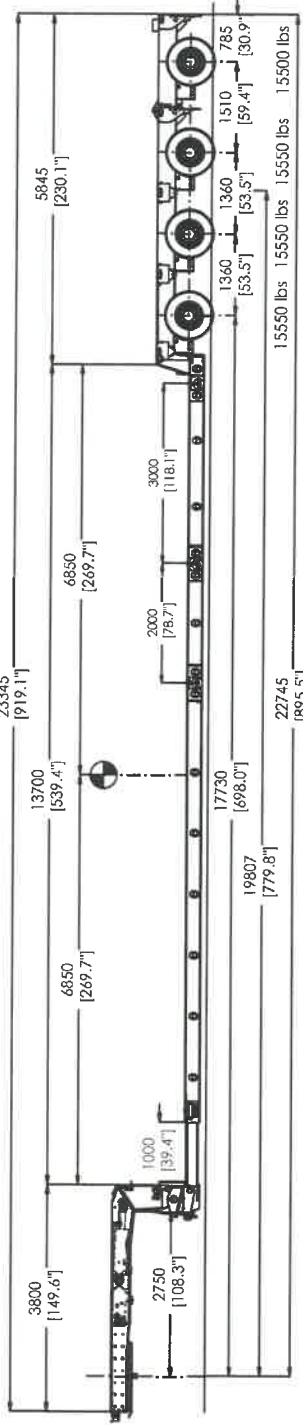

Zeichnung : WWP_TBF-009648(44)		Rev.:-	
Datum	Name	1:85	A3
gez. 17.01.19	BSC		
gepr.			

**Load Chart**  
 Mega-Z-4(3+1)L-V-KBX-A-30AT-7.70-17.5-2.54-(US)  
 Faymonville Distribution AG  
 Duarretroos 8  
 L-9990 Weiswampach  
 Tel.: +352 / 26 90 04 155  
 Fax.: +352 / 26 90 04 425  
 E-Mail : general@faymonville.com  
 Web : www.faymonville.com



Caution : the load chart does not take the deflection of the lowbed into account. The deflection of the lowbed has a direct impact on the ground clearance and on the axle compensation.





payload on 2 supports (symmetric)

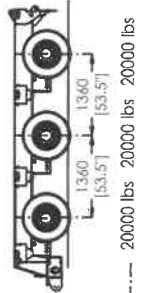
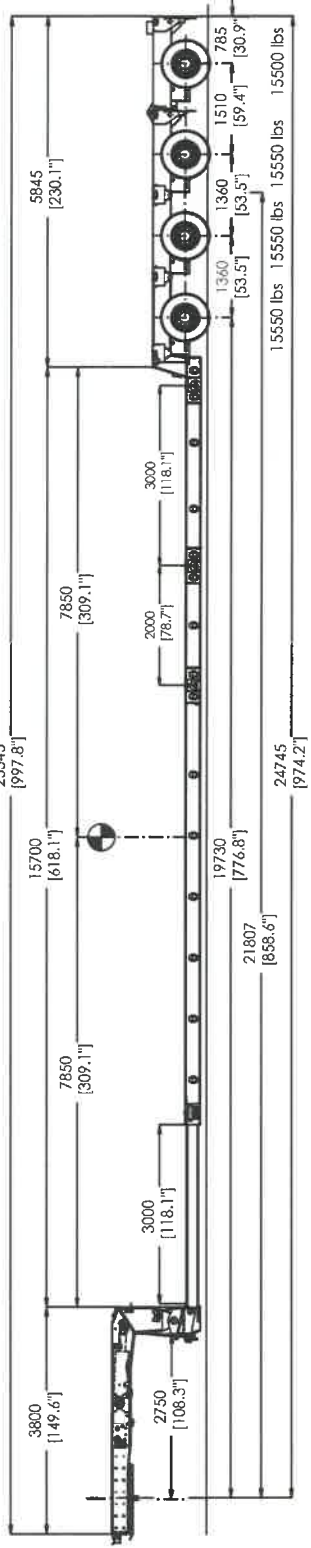
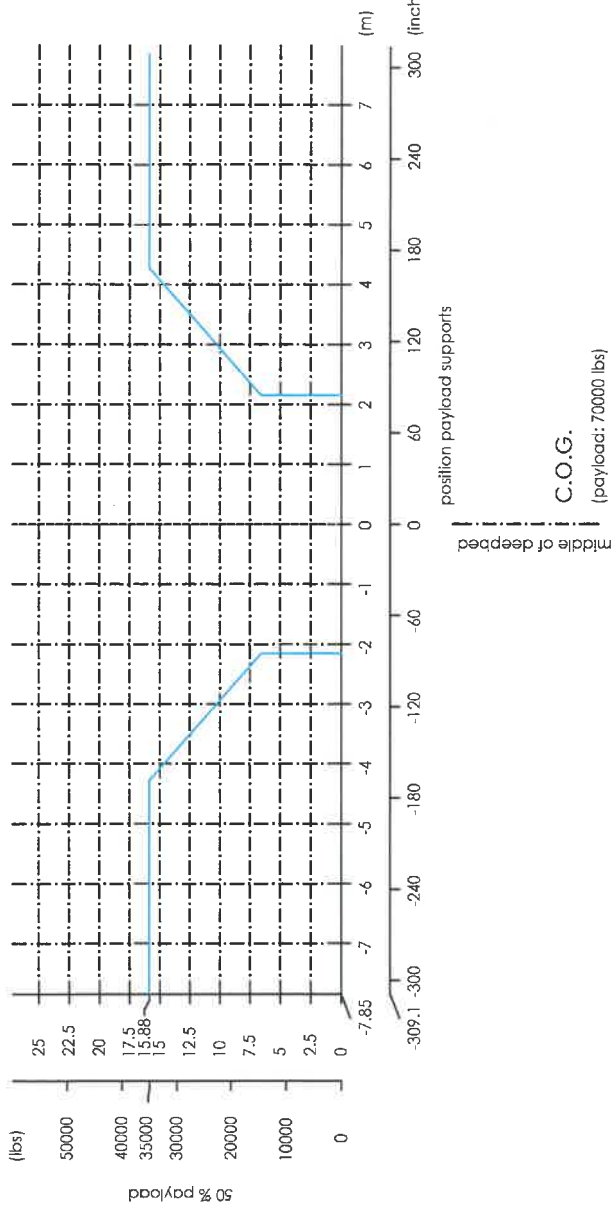

**Load Chart**

Mega-Z-4(3+)-V-KBX-A-30AT-7.70-17.5-2.54-(US)

Faymonville Distribution AG  
 Duarrestroos 8  
 L-9990 Weiswampach  
 Tel.: +352 / 26 90 04 155  
 Fax.: +352 / 26 90 04 425  
 E-Mail: general@faymonville.com  
 Web: www.faymonville.com

Zeichnung: WWP\_TBF-009648(46) Rev.: 1:85 A3

Datum	Name	gepr.
17.01.19	BSC	

**FAYMONVILLE**  
 TALKS TO THE MAX

Caution: the load chart does not take the deflection of the lowbed into account. The deflection of the lowbed has a direct impact on the ground clearance and on the axle compensation.

payload on 2 supports (symmetric)

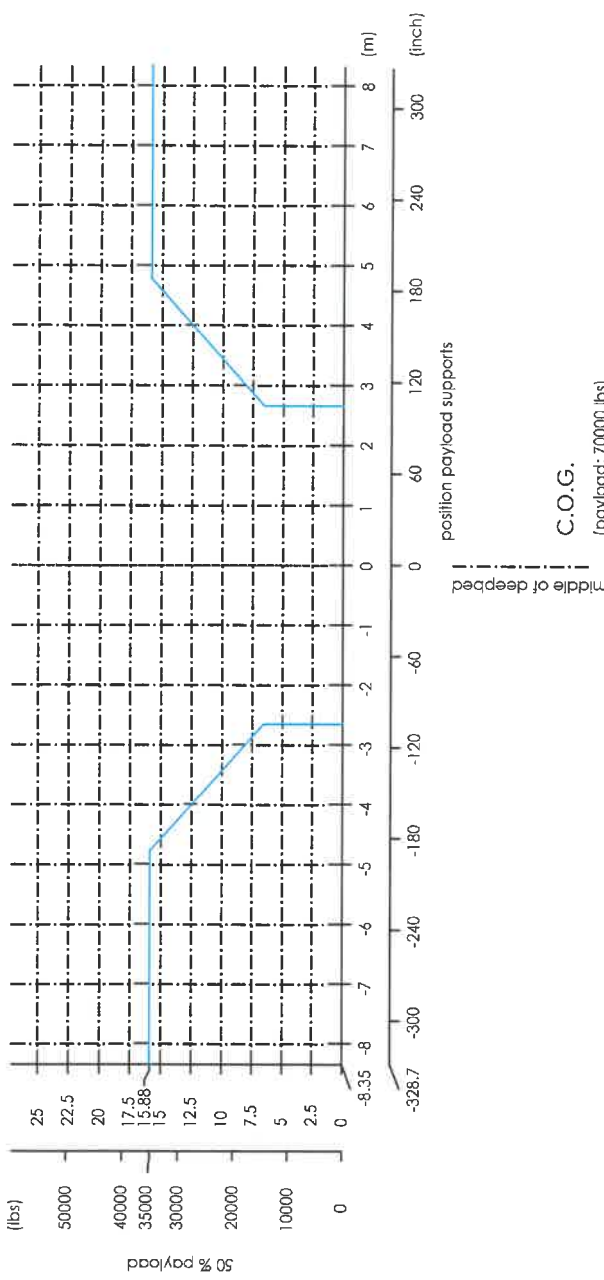

C.O.G.

(payload: 70000 lbs)

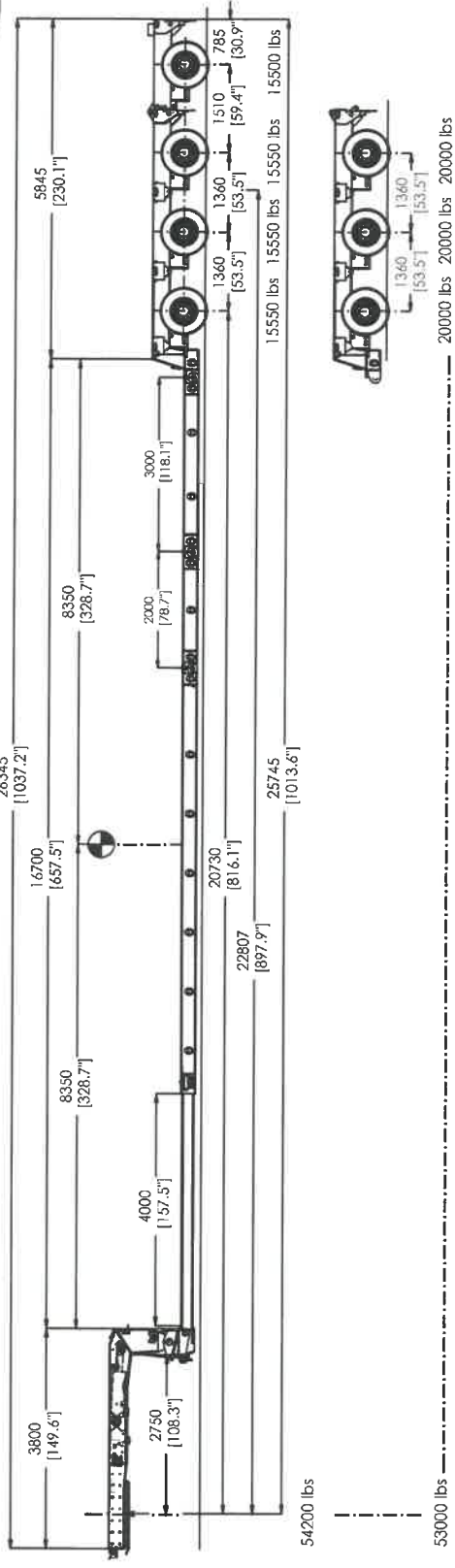

Zeichnung: WWP\_TBF-009648(47) Rev.: 1.85 A3

Datum	Name
gez. 17.01.19	BSC
gepr.	

Load Chart

Mega-Z-4(3+1)L-V-KBX-A-30AT-7.70-17.5-2.54-(US)

Faymonville Distribution AG  
 Duarrefstrooss 8  
 L-9990 Weiswampach  
 Tel.: +352 / 26 90 04 155  
 Fax.: +352 / 26 90 04 425  
 E-Mail: general@faymonville.com  
 Web: www.faymonville.com



Caution: the load chart does not take the deflection of the lowbed into account. The deflection of the lowbed has a direct impact on the ground clearance and on the axle compensation.

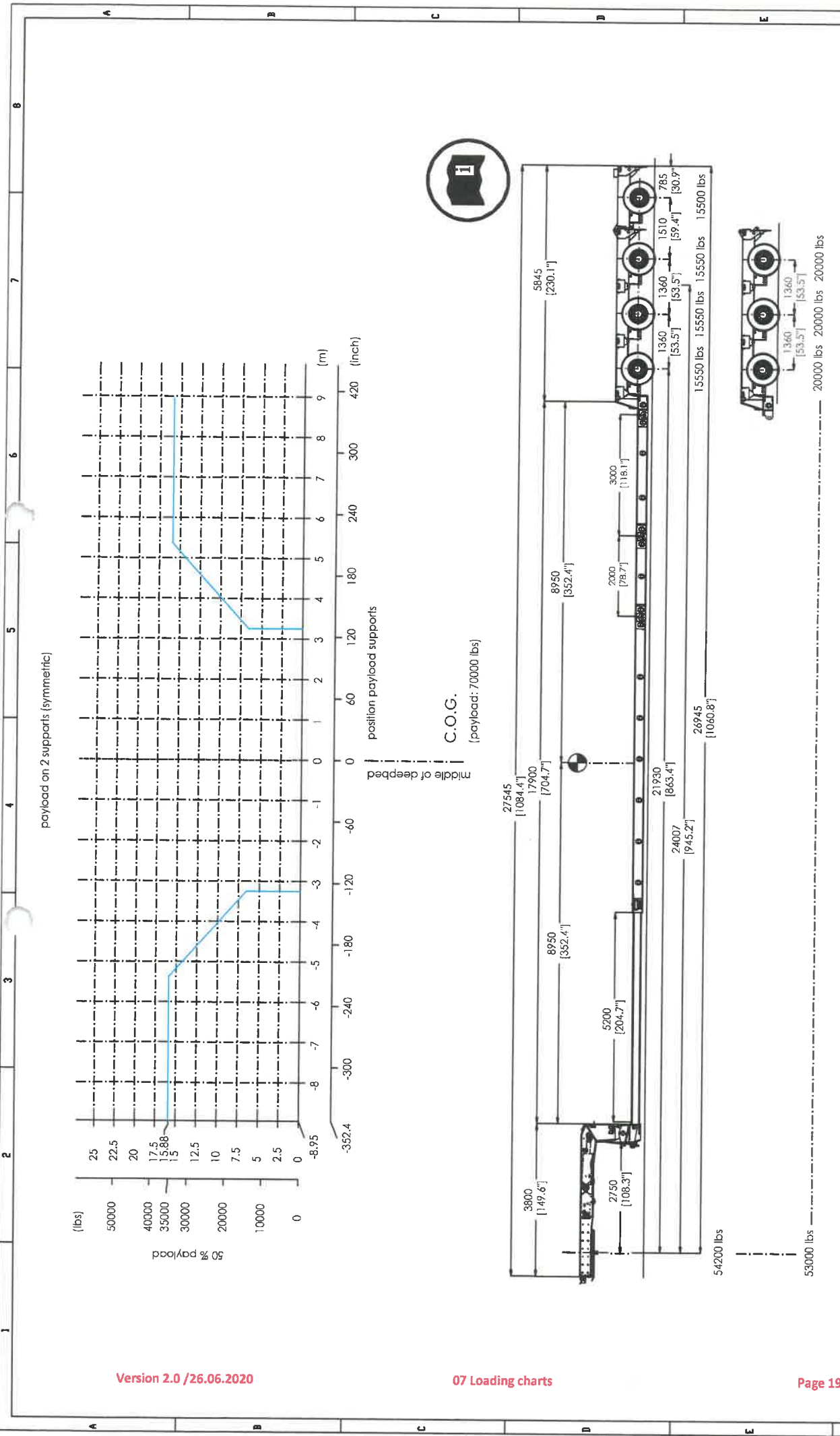

**Load Chart**

Mega-Z-4(3+)|L-V-KBX-A-30AT-7.70-17.5-2.54-US

Faymonville Distribution AG  
 Duarretstroos 8  
 L-9990 Weiswampach  
 Tel.: +352 / 26 90 04 155  
 Fax.: +352 / 26 90 04 425  
 E-Mail : general@faymonville.com  
 Web : www.faymonville.com

Zeichnung: WWP\_TBF-009648(48) Rev.:-

Datum	Name	Rev.
17.01.19	BSC	1.85 A3
gez.		
gepr.		

**FAYMONVILLE**  
TRAILERS TO THE MAX

Caution : the load chart does not take the deflection of the lowbed into account.  
 The deflection of the lowbed has a direct impact on the ground clearance and on the axle compensation.



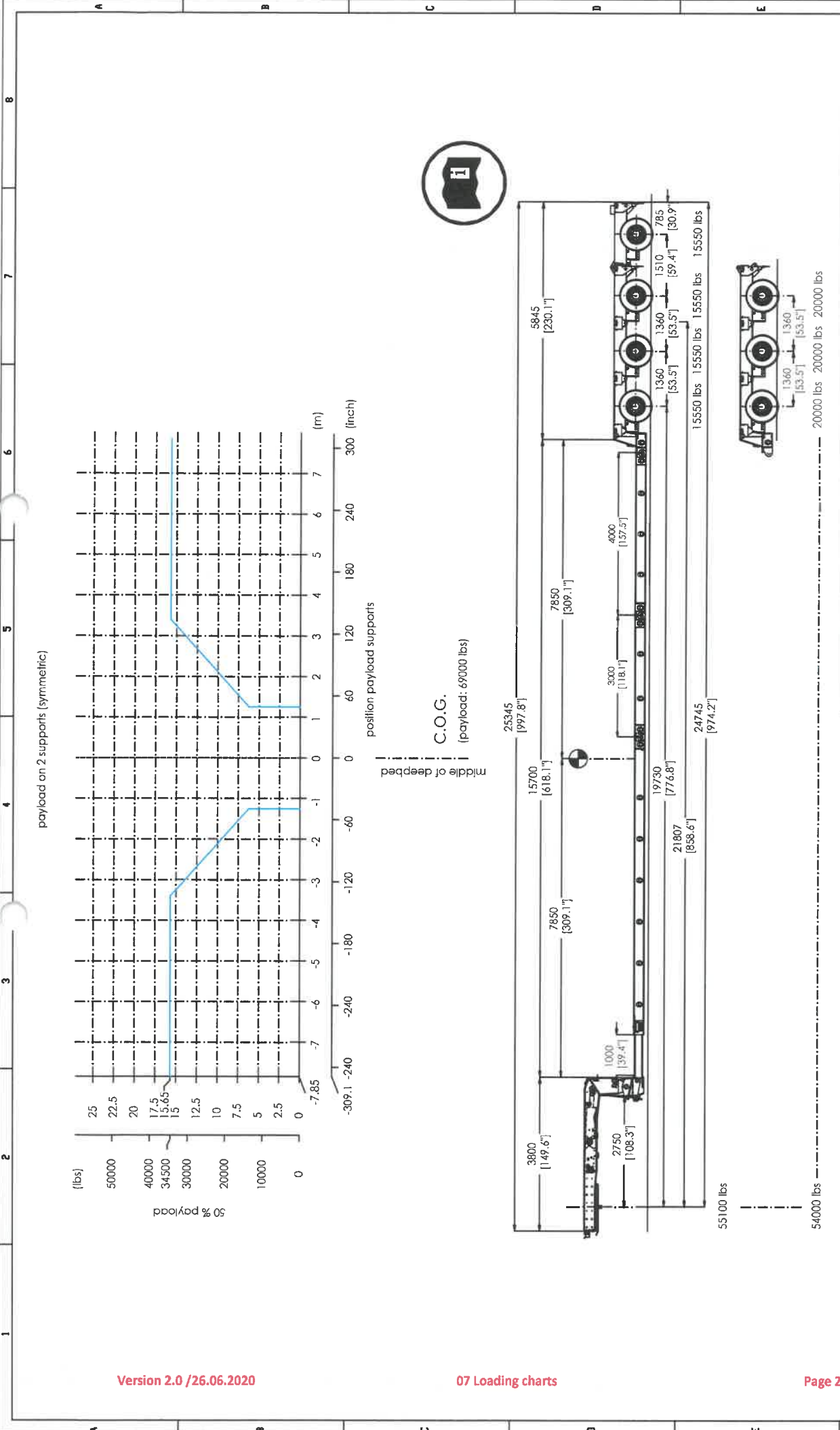

**Load Chart**  
 Mega-L-4(3+1)-V-KBX-A-30AT-7.70-17.5-2.54-(US)  
 Faymonville Distribution AG  
 Duarretroos 8  
 L-9990 Weiswampach  
 Tel.: +352 / 26 90 04 155  
 Fax.: +352 / 26 90 04 425  
 E-Mail: general@faymonville.com  
 Web: www.faymonville.com

Zeichnung: WWP\_TBF-009648(50) Rev.: -

Datum	Name	1:85	A3
gez. 17.01.19	BSC		
gepr.			

**FAYMONVILLE**  
TRAILERS TO THE MAX

Caution: the load chart does not take the deflection of the lowbed into account. The deflection of the lowbed has a direct impact on the ground clearance and on the axle compensation.



payload on 2 supports (symmetric)

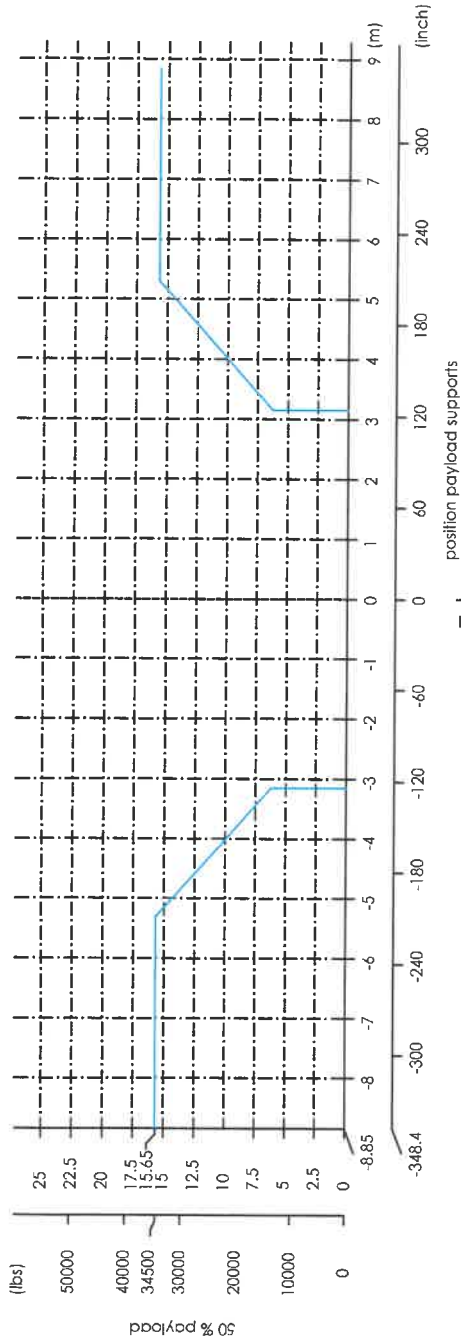

position payload supports

C.O.G.  
(payload: 69000 lbs)

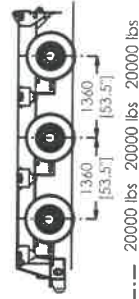
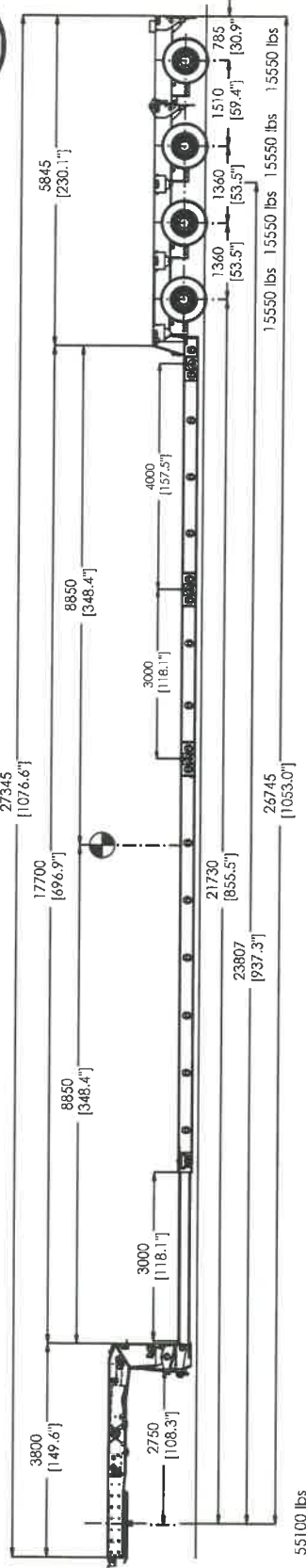

Zeichnung: WWP\_TBF-009648(52) Rev.:-

gez.	Datum	Name	1.85	A3
gez.	17.01.19	BSC		
gepr.				

**Load Chart**  
 Mega-Z-4(3+1)L-V-KBX-A-30A1-7.70-17.5-2.54-(US)  
 Faymonville Distribution AG  
 Duarrefstrooss 8  
 L-9990 Weiswampach  
 Tel.: +352 / 26 90 04 155  
 Fax.: +352 / 26 90 04 425  
 E-Mail : general@faymonville.com  
 Web : www.faymonville.com



Caution : the load chart does not take the deflection of the lowbed into account. The deflection of the lowbed has a direct impact on the ground clearance and on the axle compensation.



payload on 2 supports (symmetric)

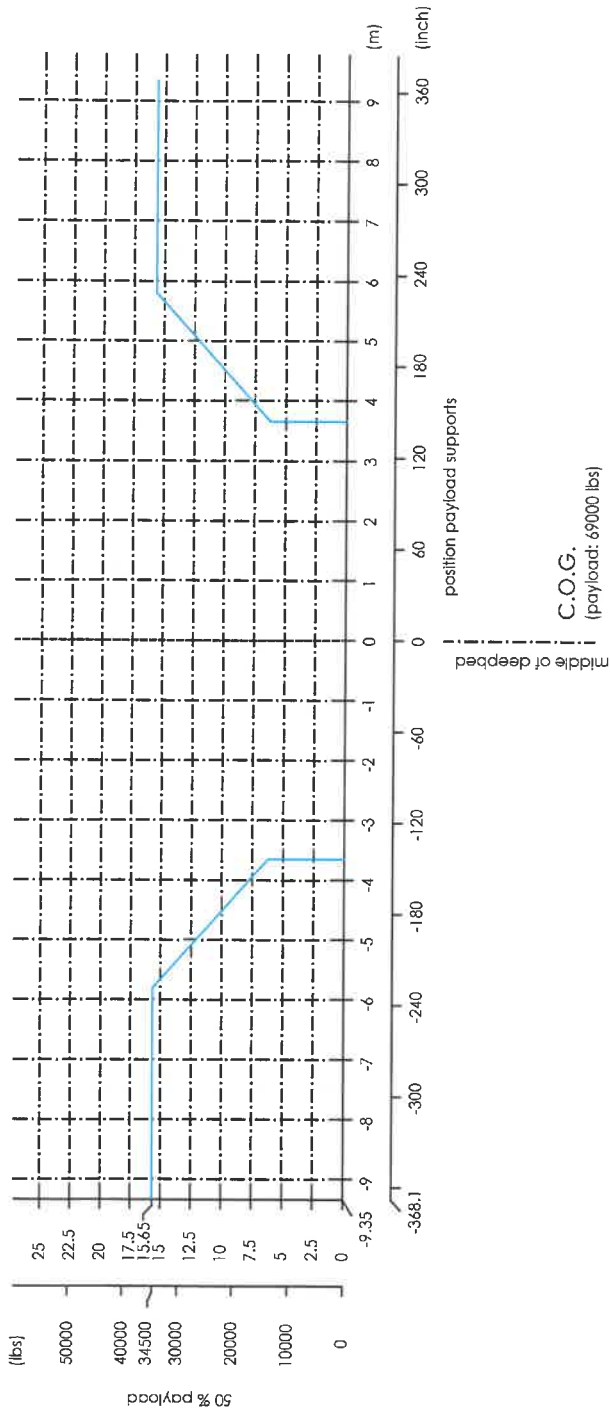

C.O.G.  
(payload: 69000 lbs)

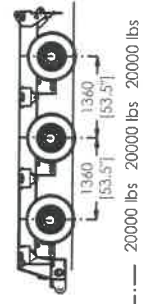
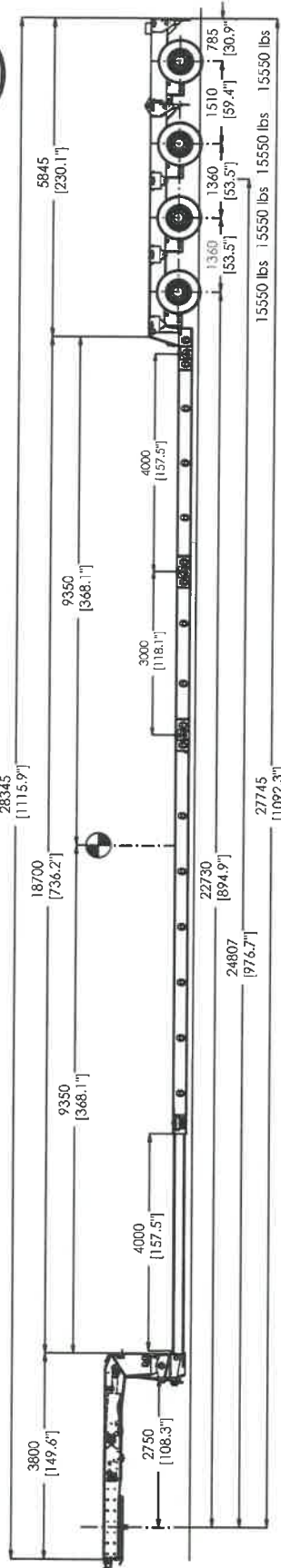

Zeichnung: WWP\_TBF-009648(53) Rev.:-

Datum	Name	Rev.
17.01.19	BSC	1:85 A3
gepr.		

**Load Chart**  
 Mega-Z-4(3+1)-V-KBX-A-30A1-7-70-17-5-2-54-(US)  
 Faymonville Distribution AG  
 Duarretroos 8  
 L-9990 Welswampach  
 Tel.: +352 / 26 90 04 155  
 Fax.: +352 / 26 90 04 425  
 E-Mail : general@faymonville.com  
 Web : www.faymonville.com



Caution : the load chart does not take the deflection of the lowbed into account. The deflection of the lowbed has a direct impact on the ground clearance and on the axle compensation.

payload on 2 supports (symmetric)

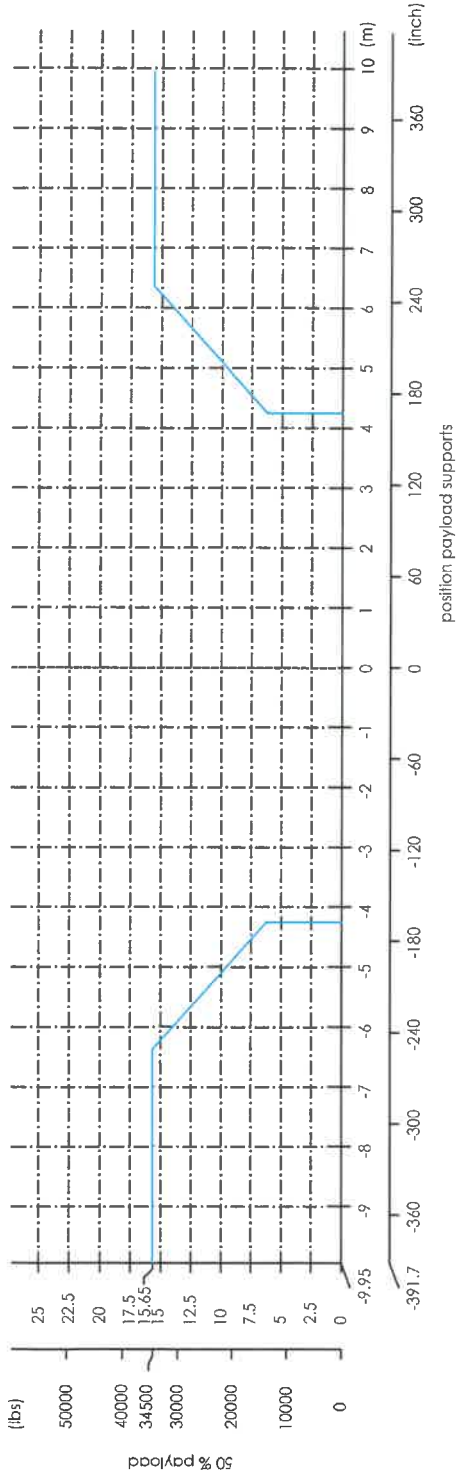

C.O.G.  
(payload: 69000 lbs)

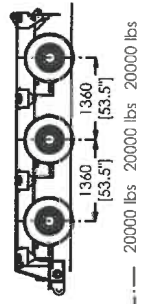
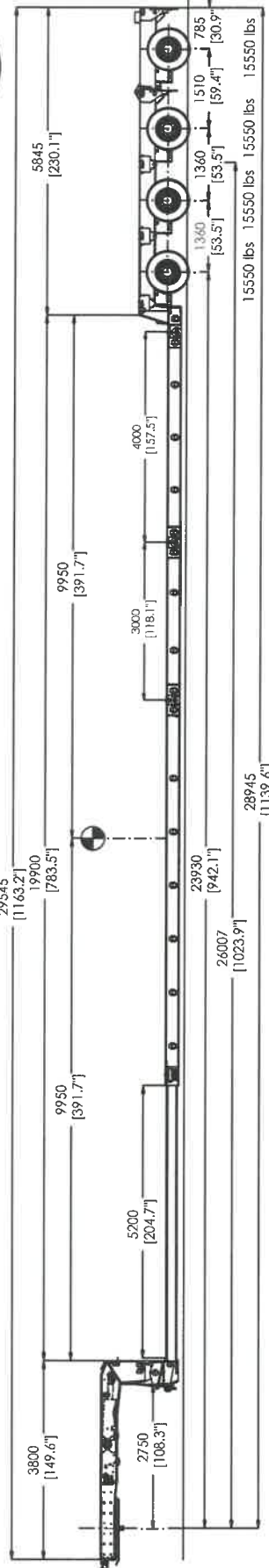

**Load Chart**  
 Mega-Z-4(3+)|L-V-KBX-A-30AT-7.70-17.5-2.54-US  
 Faymonville Distribution AG  
 Duarretroos 8  
 L-9990 Weiswampach  
 Tel.: +352 / 26 90 04 155  
 Fax: +352 / 26 90 04 425  
 E-Mail : general@faymonville.com  
 Web : www.faymonville.com

Zeichnung : WWP_TBF-009648(54)		Rev.:-	
Datum	Name	1:85	A3
gez. 17.01.19	BSC		
gepr.			



Caution : the load chart does not take the deflection of the lowbed into account. The deflection of the lowbed has a direct impact on the ground clearance and on the axle compensation.

payload on 2 supports (symmetric)

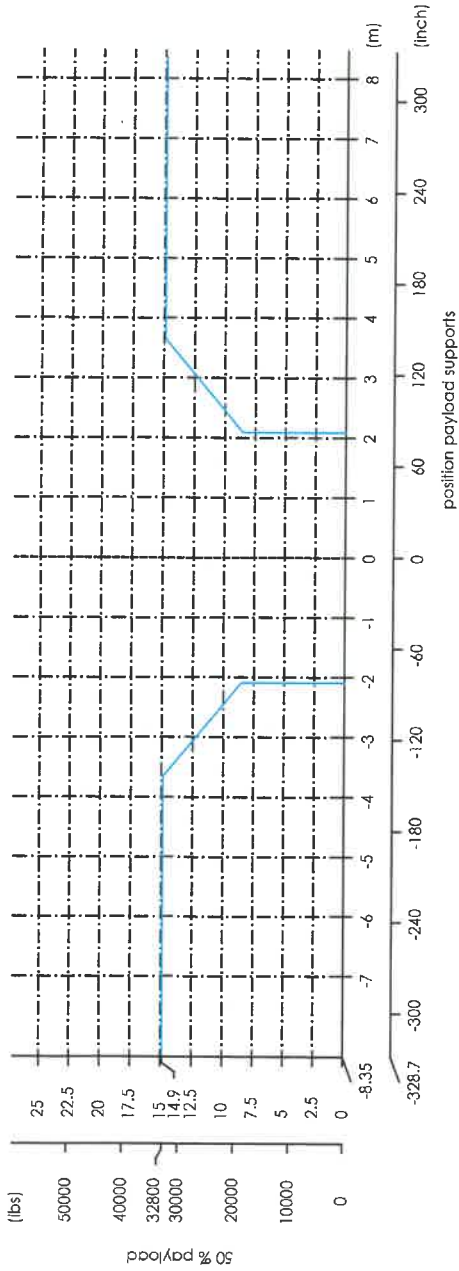

C.O.G.  
(payload: 65600 lbs)

Middle of deepbed

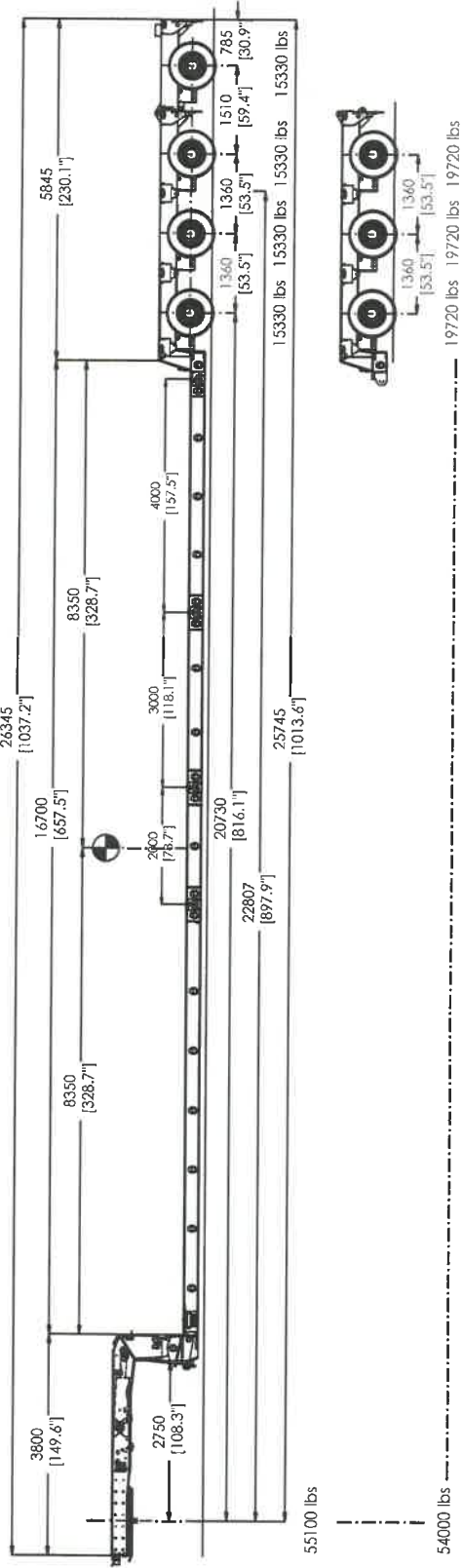

Zeichnung: WWP_TBF-009648(55)		Rev.:-
Datum	Name	1:85 A3
gez. 17.01.19	BSC	
gepr.		

**Load Chart**  
 Mega-Z-4(3+1)L-V-KBX-A-30AT-7.70-17.5-2.54-(US)  
 Faymonville Distribution AG  
 Duarrestroos 8  
 L-9990 Weiswampach  
 Tel.: +352 / 26 90 04 155  
 Fax.: +352 / 26 90 04 425  
 E-Mail : general@faymonville.com  
 Web : www.faymonville.com



Caution : the load chart does not take the deflection of the lowbed into account. The deflection of the lowbed has a direct impact on the ground clearance and on the axle compensation.

payload on 2 supports (symmetric)

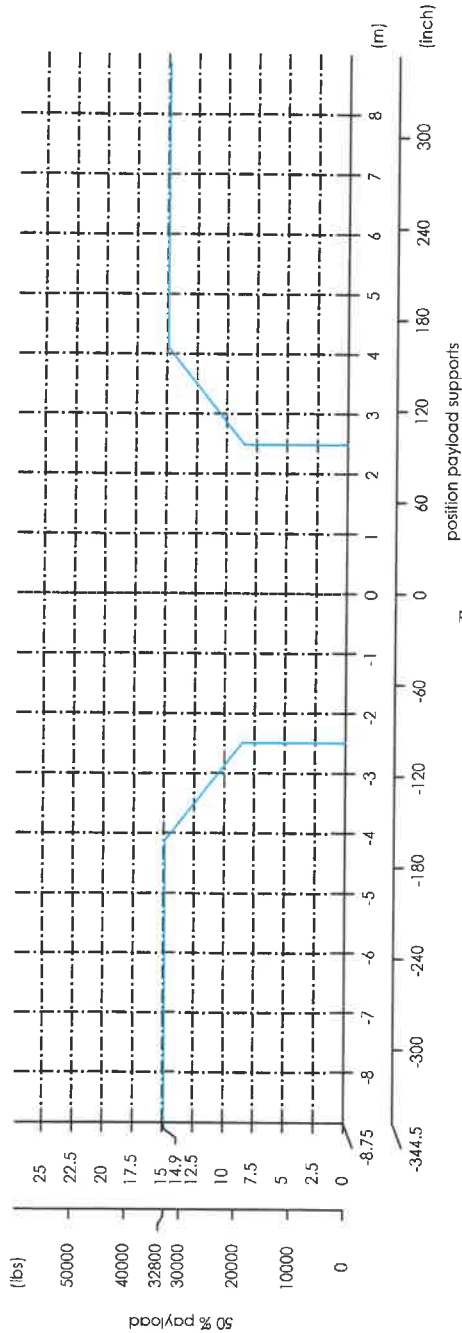

C.O.G.  
(payload: 65600 lbs)

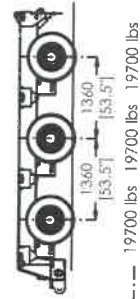
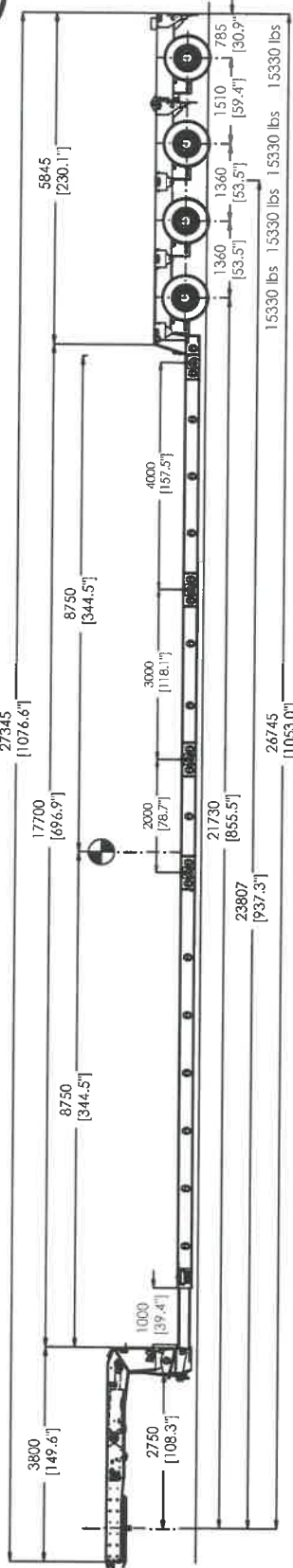

Zeichnung: WWP\_TBF-009648(56) Rev.:-

Datum	Name	1:85	A3
gez. 17.01.19	BSC		
gepr.			

**Load Chart**  
 Mega-Z-4(3+1)-V-KBX-A-30A1-7.70-17.5-2.54-(US)  
 Faymonville Distribution AG  
 Duarrefstroos 8  
 L-9990 Weiswampach  
 Tel.: +352 / 26 90 04 155  
 Fax.: +352 / 26 90 04 425  
 E-Mail : general@faymonville.com  
 Web : www.faymonville.com



Caution : the load chart does not take the deflection of the lowbed into account. The deflection of the lowbed has a direct impact on the ground clearance and on the axle compensation.

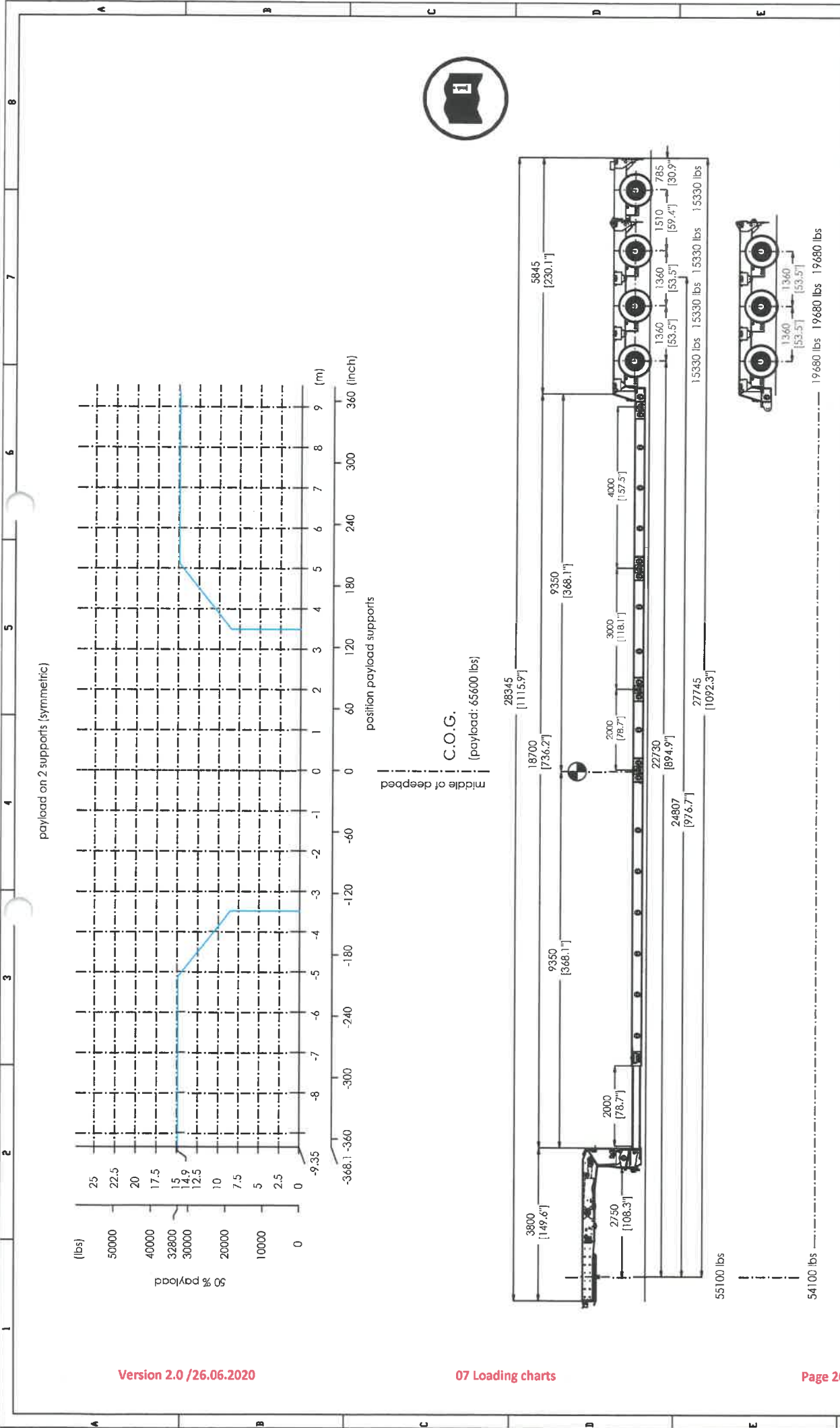

**Load Chart**  
 Mega-Z-4(3+1)-V-KBX-A-30AT-7.70-17.5-2.54-(US)  
 Faymonville Distribution AG  
 Duarrefstross 8  
 L-9990 Weiswampach  
 Tel.: +352 / 26 90 04 155  
 Fax.: +352 / 26 90 04 425  
 E-Mail: general@faymonville.com  
 Web: www.faymonville.com

Zeichnung: WWP_TBF-009648(57)		Rev.:-	
Datum	Name	1:85	A3
gez. 17.01.19	BSC		
gepr.			



Caution: the load chart does not take the deflection of the lowbed into account.  
 The deflection of the lowbed has a direct impact on the ground clearance and on the axle compensation.

payload on 2 supports (symmetric)

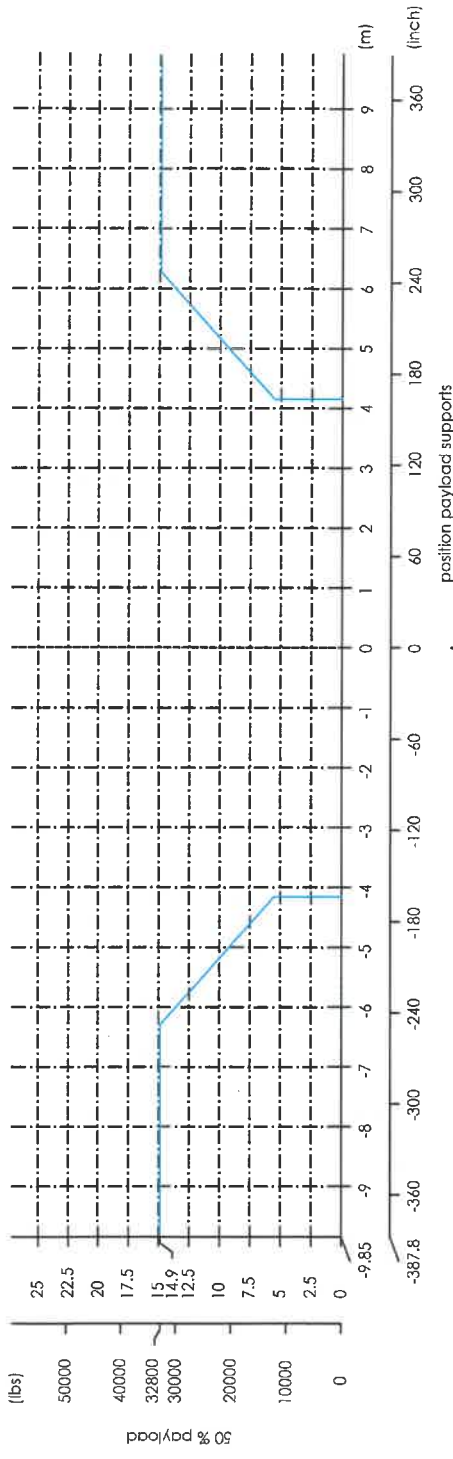

C.O.G.  
(payload: 65600 lbs)

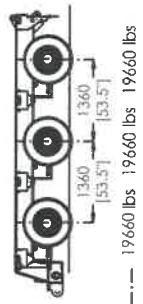
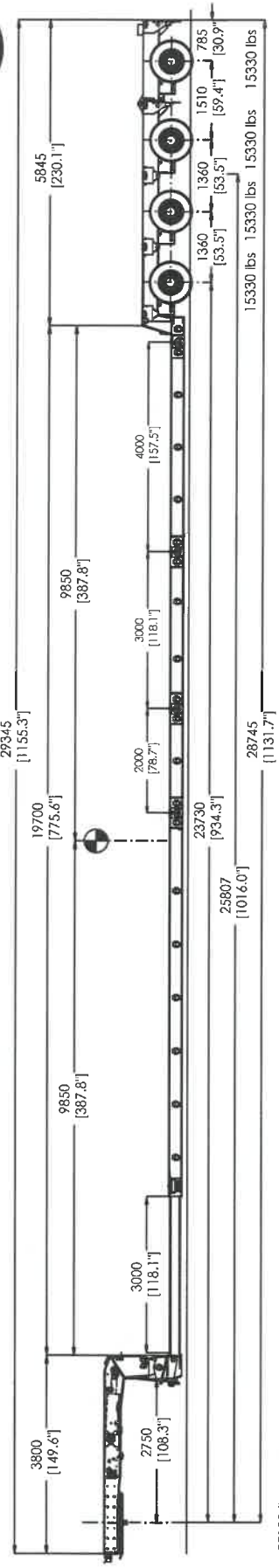

Zeichnung: WWF\_TBF-009648(58)  
Rev.: 1.85 A3

Datum	Name	Rev.
17.01.19	BSC	1.85 A3
gez.		
gppr.		

**FAYMONVILLE**  
TRAILERS TO THE MAX

Faymonville Distribution AG  
Duarreistroos 8  
L-9990 Weiswampach  
Tel.: +352 / 26 90 04 155  
Fax: +352 / 26 90 04 425  
E-Mail: general@faymonville.com  
Web: www.faymonville.com

Caution: the load chart does not take the deflection of the lowbed into account. The deflection of the lowbed has a direct impact on the ground clearance and on the axle compensation.

payload on 2 supports (symmetric)

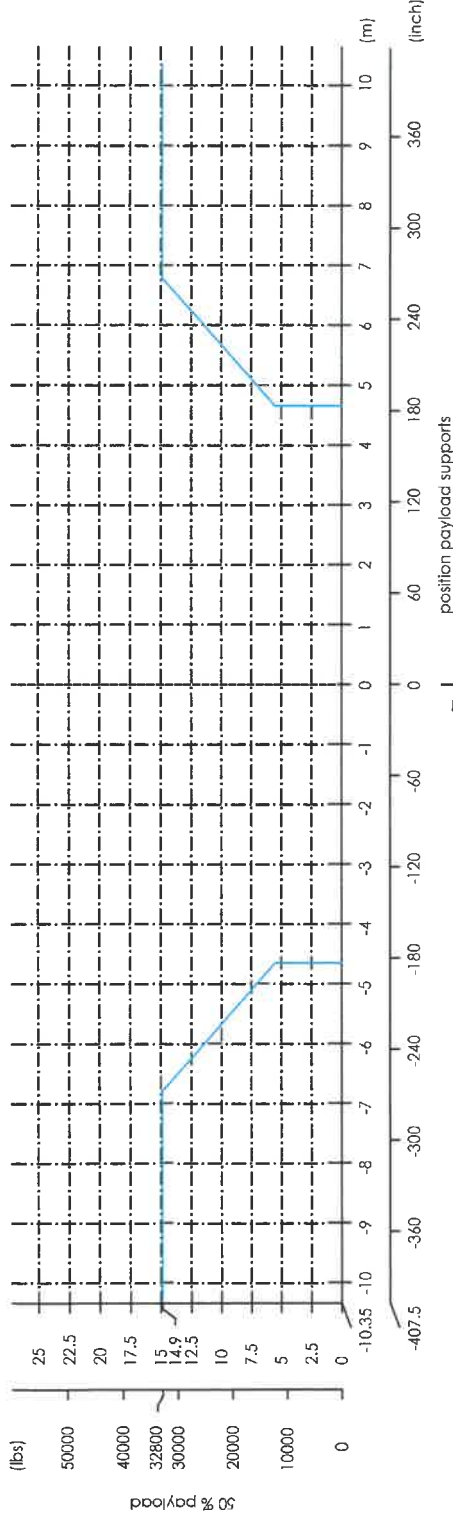

C.O.G.  
(payload: 65600 lbs)

middle of deepbed

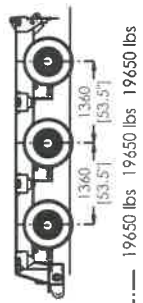
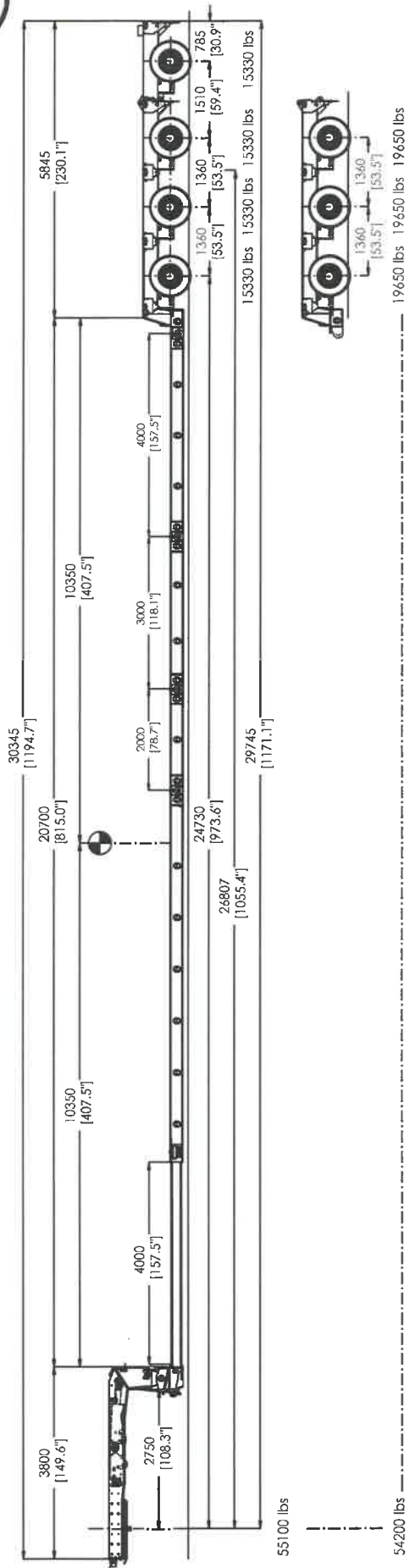

**Load Chart**  
 Mega-Z-4(3+1)-V-KBX-A-30AT-7.70-17.5-2.54-(US)

Faymonville Distribution AG  
 Duarrestroos 8  
 L-9990 Weiswampach  
 Tel.: +352 / 26 90 04 155  
 Fax.: +352 / 26 90 04 425  
 E-Mail: general@faymonville.com  
 Web: www.faymonville.com

Zeichnung: WWP_TBF-009648(59)		Rev.:-
Datum	Name	1:85 A3
gez. 17.01.19	BSC	
gepr.		



Caution: the load chart does not take the deflection of the lowbed into account.  
 The deflection of the lowbed has a direct impact on the ground clearance and on the axle compensation.

payload on 2 supports (symmetric)

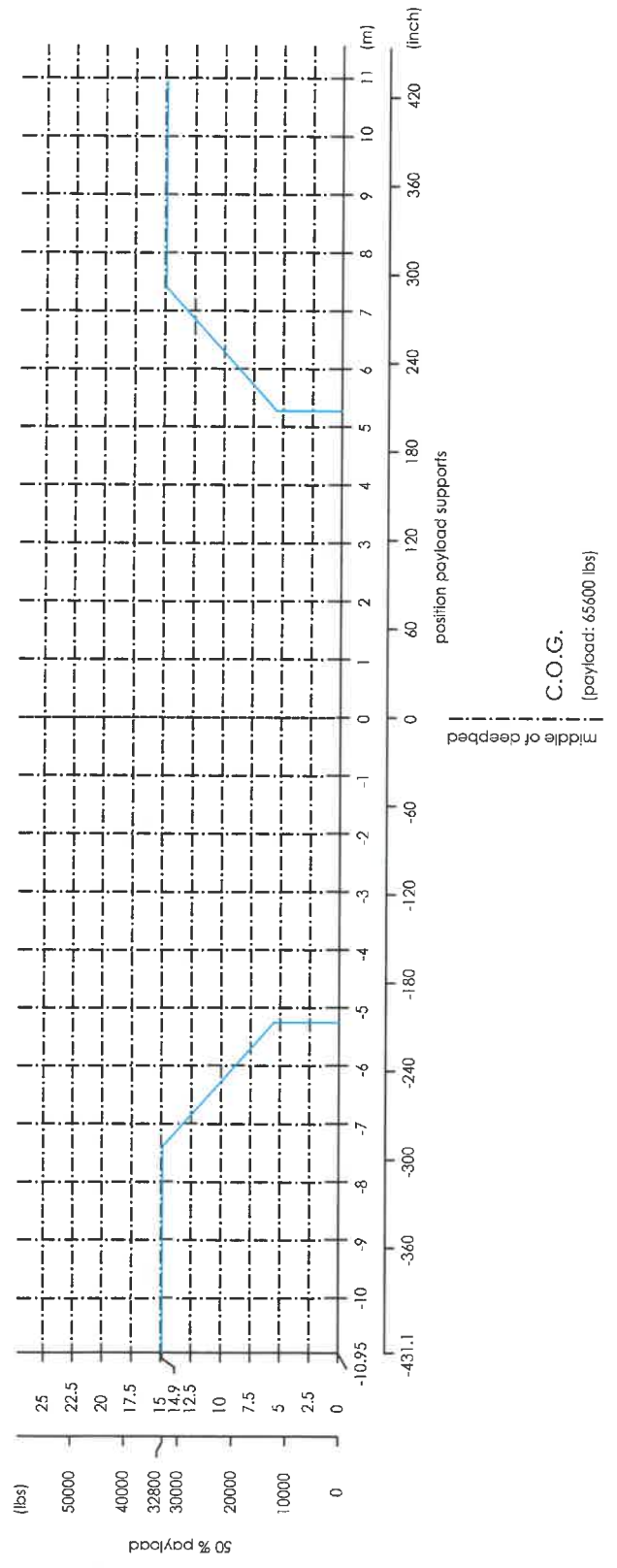

Version 2.0 / 26.06.2020

07 Loading charts

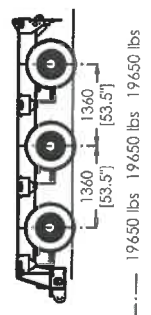
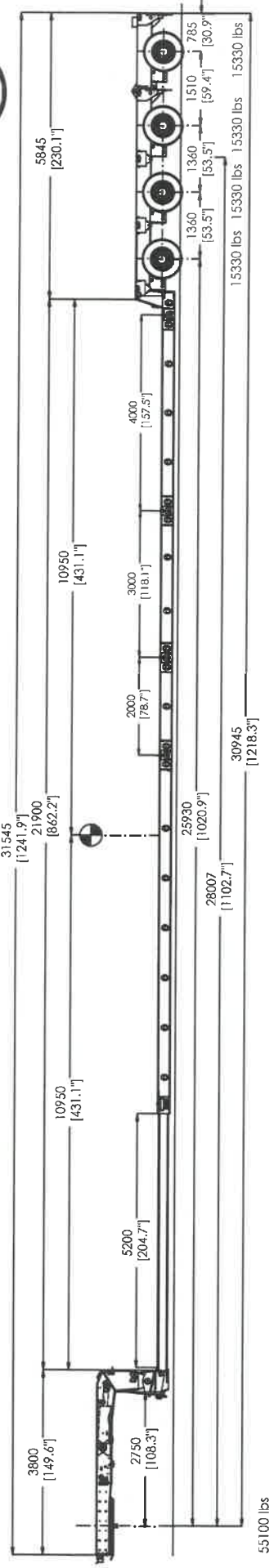

54200 lbs

**Load Chart**  
 Mega-Z-4(3+1)-V-KBX-A-30A1-7-70-17-5-2-54-(US)  
 Faymonville Distribution AG  
 Duarretstroos 8  
 L-9990 Weiswampach  
 Tel.: +352 / 26 90 04 155  
 Fax.: +352 / 26 90 04 425  
 E-Mail : general@faymonville.com  
 Web : www.faymonville.com

Zeichnung : WWP_TBF-009648(60)		Rev.:-
Datum	Name	1:85 A3
gez. 17.01.19	BSC	
gepr.		



Cauton : the load chart does not take the deflection of the lowbed into account.  
 The deflection of the lowbed has a direct impact on the ground clearance and on the axle compensation.



payload on 2 supports (symmetric)

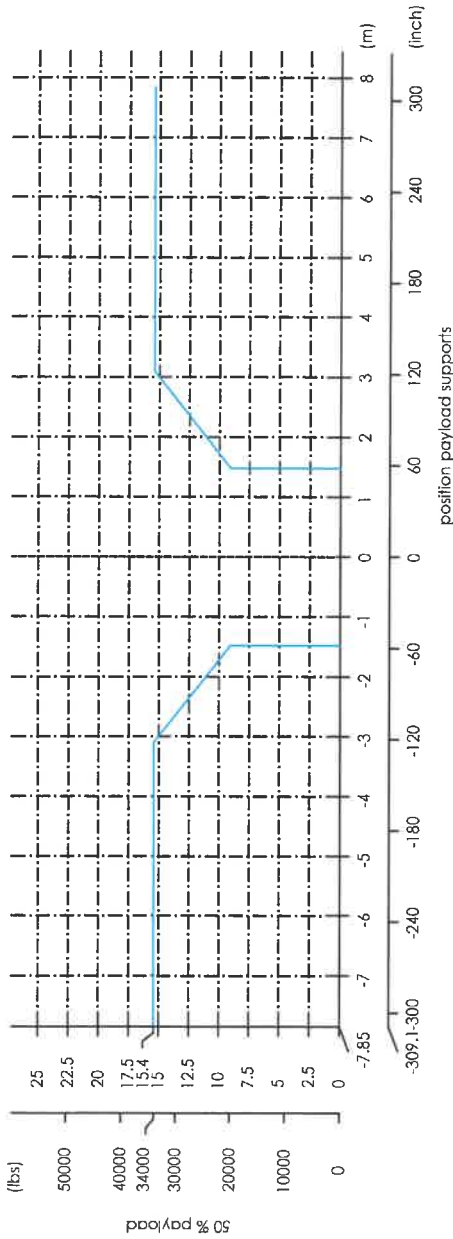

Middle of deeped  
C.O.G.  
(payload: 68000 lbs)

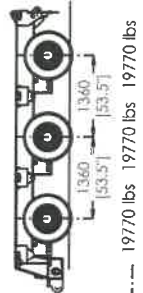
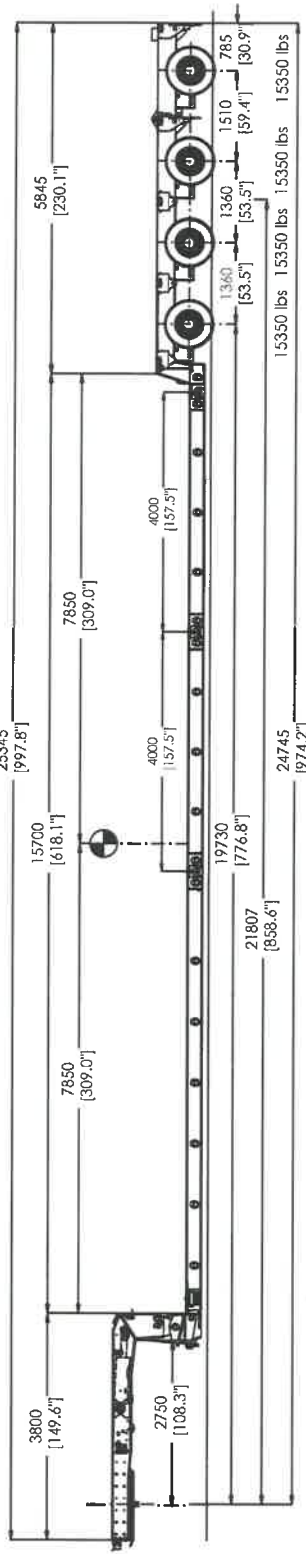

**Load Chart**  
 Mega-Z-4(3+1)-V-KBX-A-30AT-7.70-17.5-2.54-(US)  
 Faymonville Distribution AG  
 Duarretstroos 8  
 L-9990 Weiswampoch  
 Tel.: +352 / 26 90 04 155  
 Fax.: +352 / 26 90 04 425  
 E-Mail : general@faymonville.com  
 Web : www.faymonville.com

Zeichnung : WWP_TBF-009648(61)		Rev.:-	
gez.	Datum	Name	1:85 A3
gepr.	17.01.19	BSC	



Caution : the load chart does not take the deflection of the lowbed into account.  
 The deflection of the lowbed has a direct impact on the ground clearance and on the axle compensation.

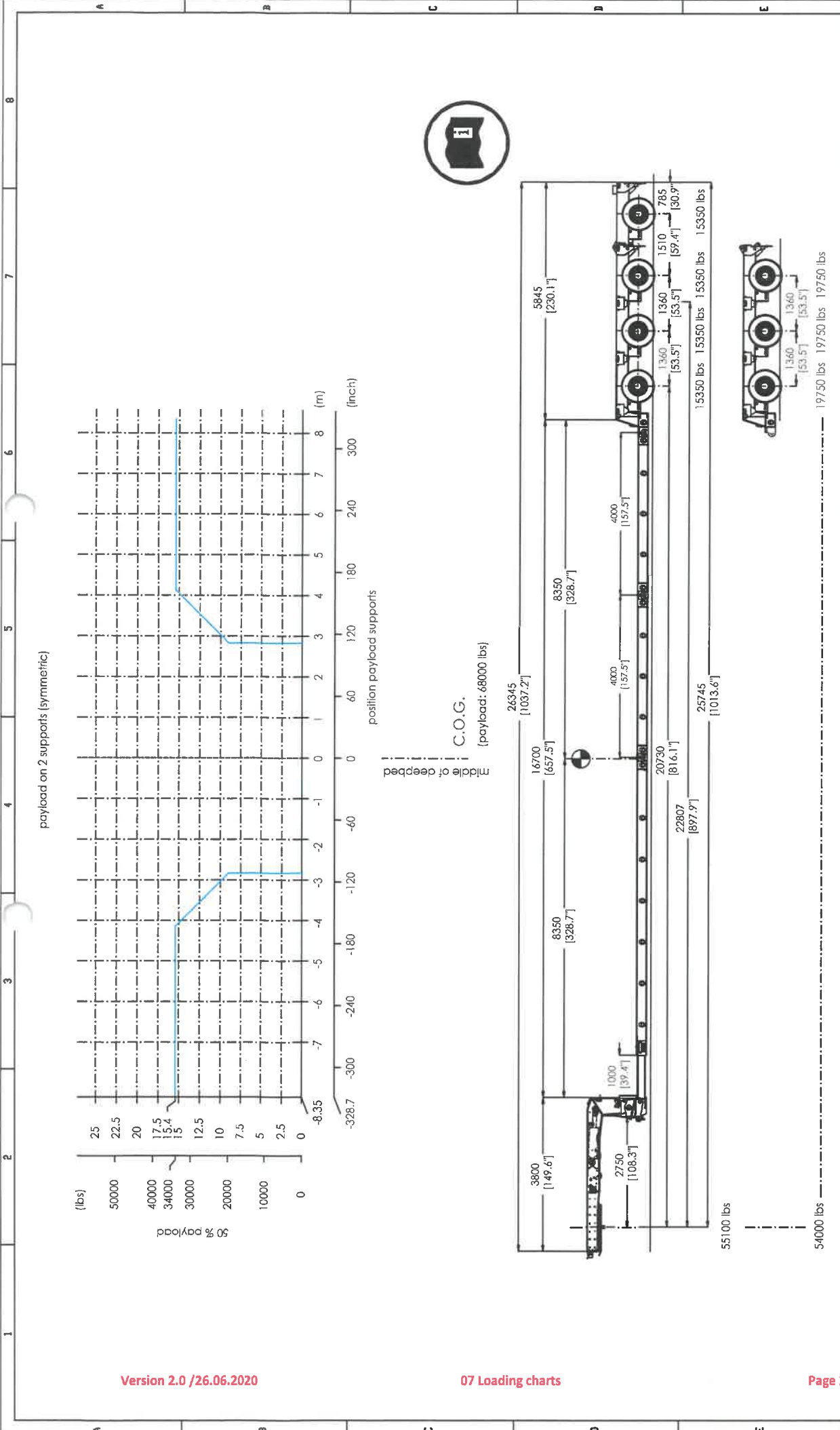

**Load Chart**  
 Mega-Z-4(3+1)-V-KBX-A-30AT-7.0-17.5-2.54-(US)

Faymonville Distribution AG  
 Duarrestroos 8  
 L-9990 Weiswampach  
 Tel.: +352 / 26 90 04 155  
 Fax.: +352 / 26 90 04 425  
 E-Mail: general@faymonville.com  
 Web: www.faymonville.com

Zeichnung: WWP\_TBF-009648(62) Rev.: A3

Datum	Name
gez. 17.01.19	BSC
gepr.	



Caution: the load chart does not take the deflection of the lowbed into account. The deflection of the lowbed has a direct impact on the ground clearance and on the axle compensation.

payload on 2 supports (symmetric)

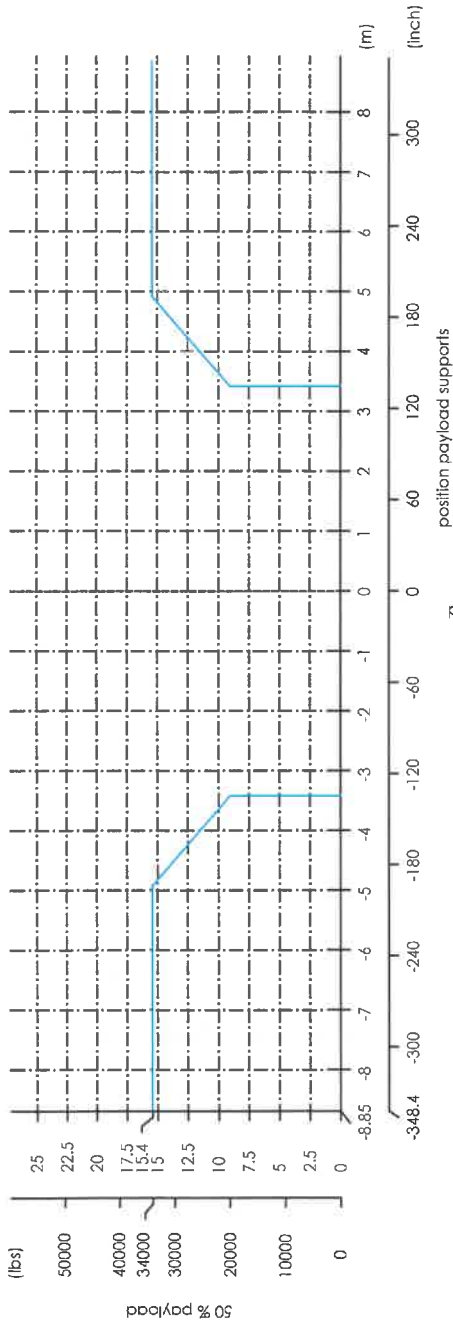

C.O.G.  
(payload: 68000 lbs)

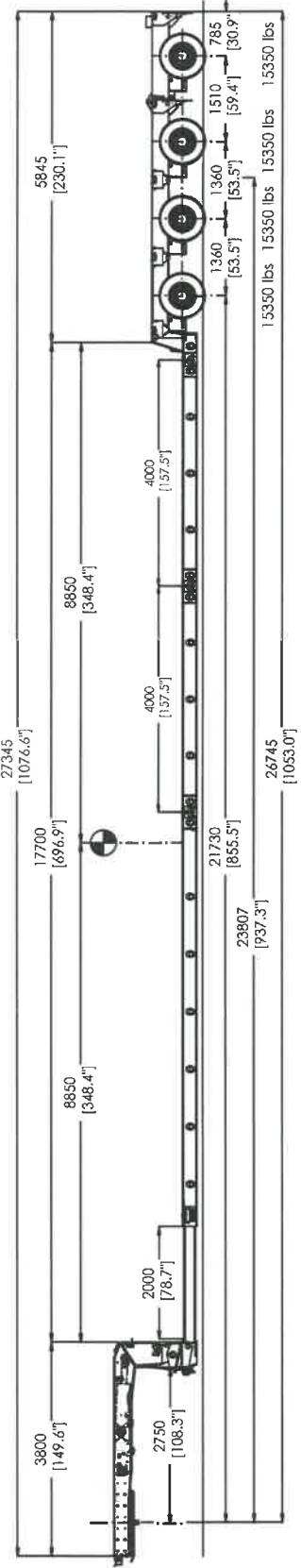

Zeichnung: WWP\_TBF-009648(63) Rev.-: 1:85 A3

Datum	Name
gez. 17.01.19	BSC
gepr.	

**Load Chart**  
 Mega-Z-4(3+1)-V-KBX-A-30AT-7.70-17.5-2.54-(US)  
 Faymonville Distribution AG  
 Duarretstroos 8  
 L-9990 Weiswampach  
 Tel.: +352 / 26 90 04 155  
 Fax.: +352 / 26 90 04 425  
 E-Mail: general@faymonville.com  
 Web: www.faymonville.com



Caution: the load chart does not take the deflection of the lowbed into account. The deflection of the lowbed has a direct impact on the ground clearance and on the axle compensation.

payload on 2 supports (symmetric)

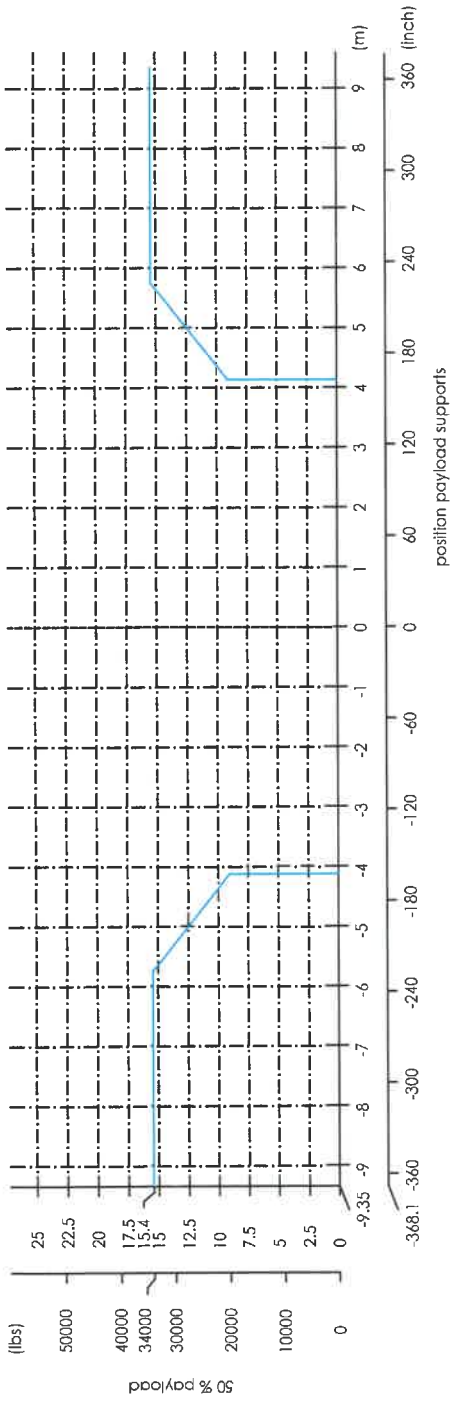

C.O.G.  
(payload: 68000 lbs)

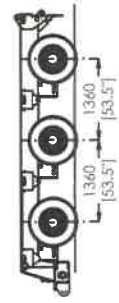
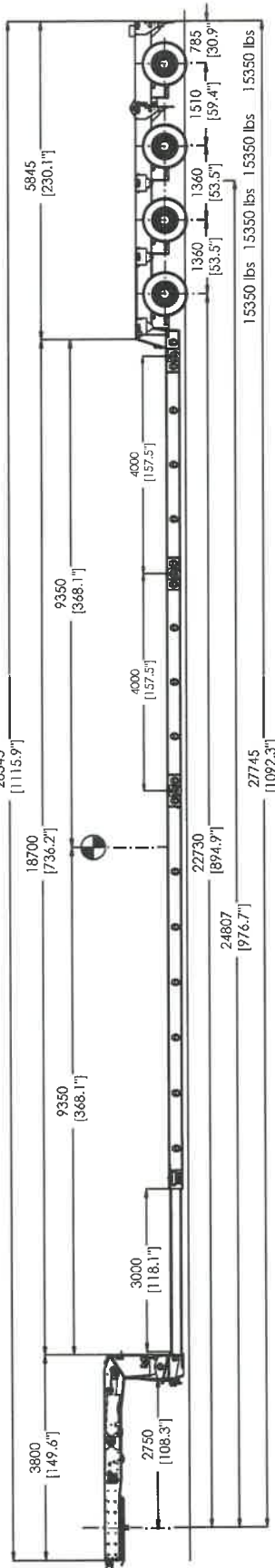

Zeichnung: WWP\_TBF-009648(64) Rev.:-

gez.	17.01.19	Name	BSC	1:85	A3
gepr.					

FAYMONVILLE  
TRAILERS TO THE MAX

Load Chart

Mega-Z-4(3+1)-V-KBX-A-30AT-7.70-17.5-2.54-(US)

Faymonville Distribution AG  
Duarrelstrooss 8  
L-9990 Weiswampach  
Tel.: +352 / 26 90 04 155  
Fax.: +352 / 26 90 04 425  
E-Mail : general@faymonville.com  
Web : www.faymonville.com

Caution : the load chart does not take the deflection of the lowbed into account.  
The deflection of the lowbed has a direct impact on the ground clearance and on the axle compensation.

payload on 2 supports (symmetric)

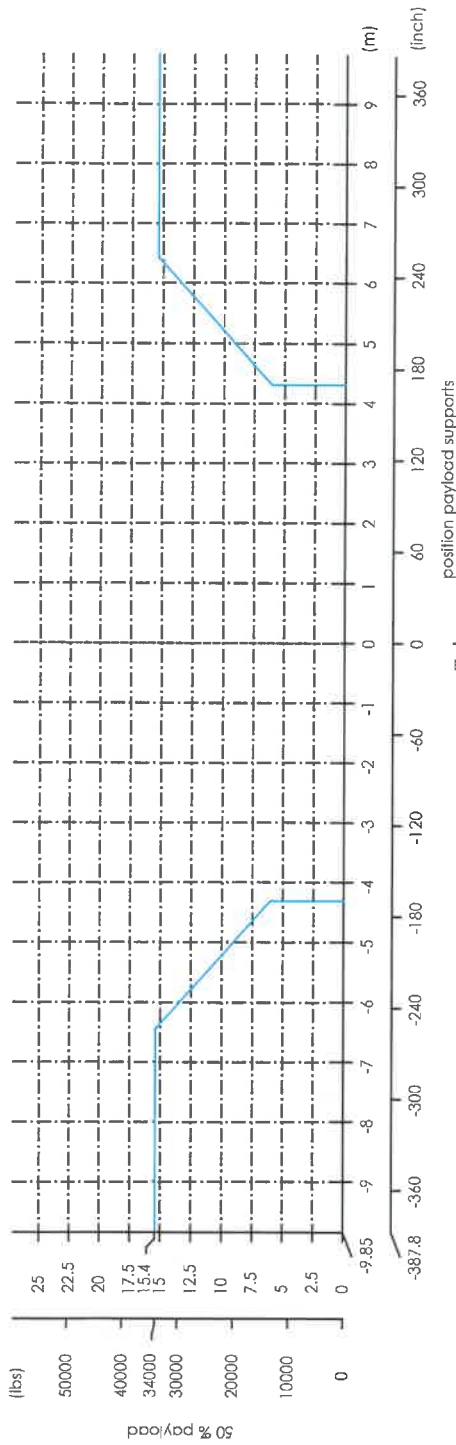

C.O.G.  
(payload: 68000 lbs)

middle of deepbed

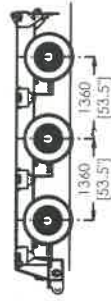
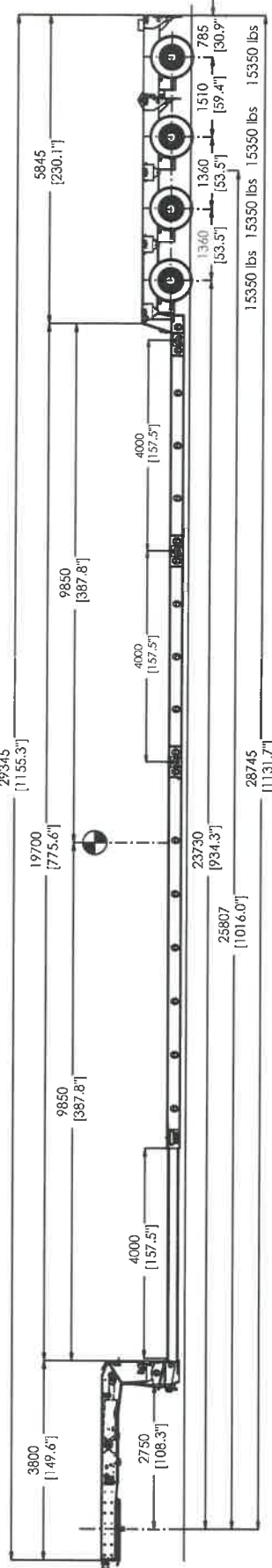

55100 lbs

54100 lbs

Zeichnung: WWP\_TBF-009648(65)

Rev.:-

Datum	Name	Rev.
gez. 17.01.19	BSC	1:85 A3
gepr.		

Load Chart

Mega-Z-4(3+1)-V-KBX-A-30AT-7.70-17.5-2.54-US

Faymonville Distribution AG  
 Duarrefstrooss 8  
 L-9990 Weiswampach  
 Tel.: +352 / 26 90 04 155  
 Fax.: +352 / 26 90 04 425  
 E-Mail: general@faymonville.com  
 Web: www.faymonville.com



Caution: the load chart does not take the deflection of the lowbed into account. The deflection of the lowbed has a direct impact on the ground clearance and on the axle compensation.

payload on 2 supports (symmetric)

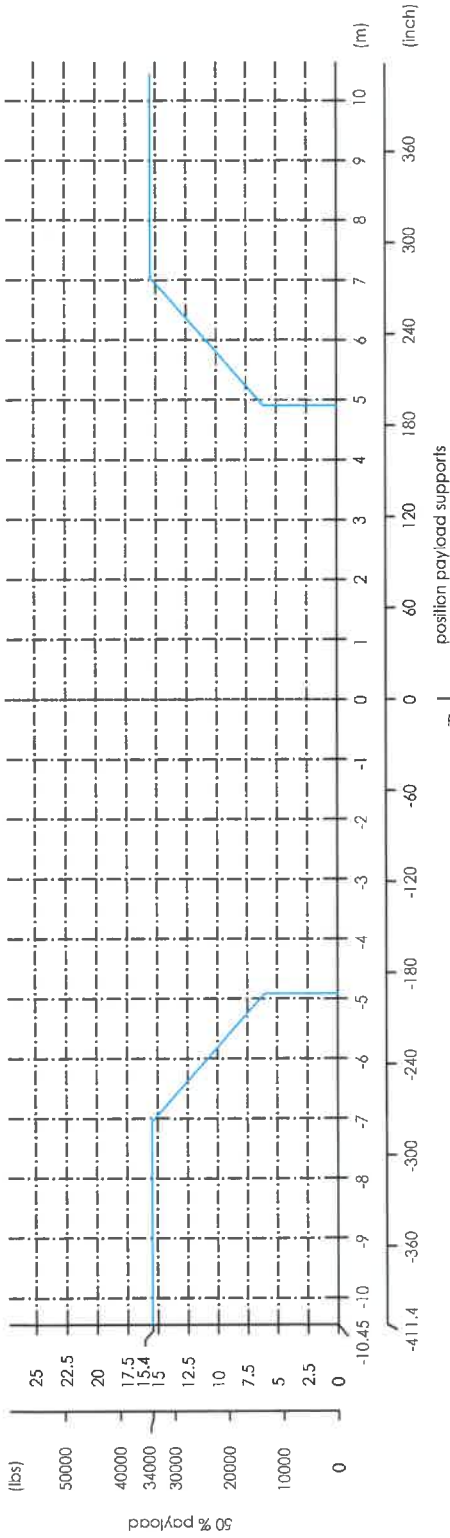

C.O.G.  
(payload: 68000 lbs)

Middle of deepbed

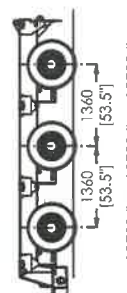
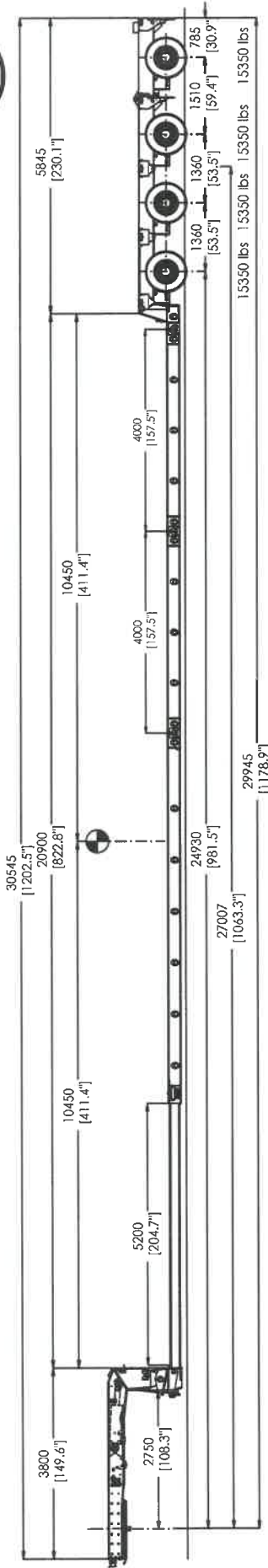

55100 lbs

54150 lbs

Zeichnung: WWP\_TBF-009648(66)

Rev.:

Datum	Name	Rev.
gez. 17.01.19	BSC	1:85 A3
gepr.		

Load Chart

Mega-Z(3+1)L-V-KBX-A-30AT-7.70-17.5-2.54-(US)

Faymonville Distribution AG  
Duarreisfroos 8  
L-9990 Weiswampach  
Tel.: +352 / 26 90 04 155  
Fax.: +352 / 26 90 04 425  
E-Mail: general@faymonville.com  
Web: www.faymonville.com



Caution: the load chart does not take the deflection of the lowbed into account. The deflection of the lowbed has a direct impact on the ground clearance and on the axle compensation.

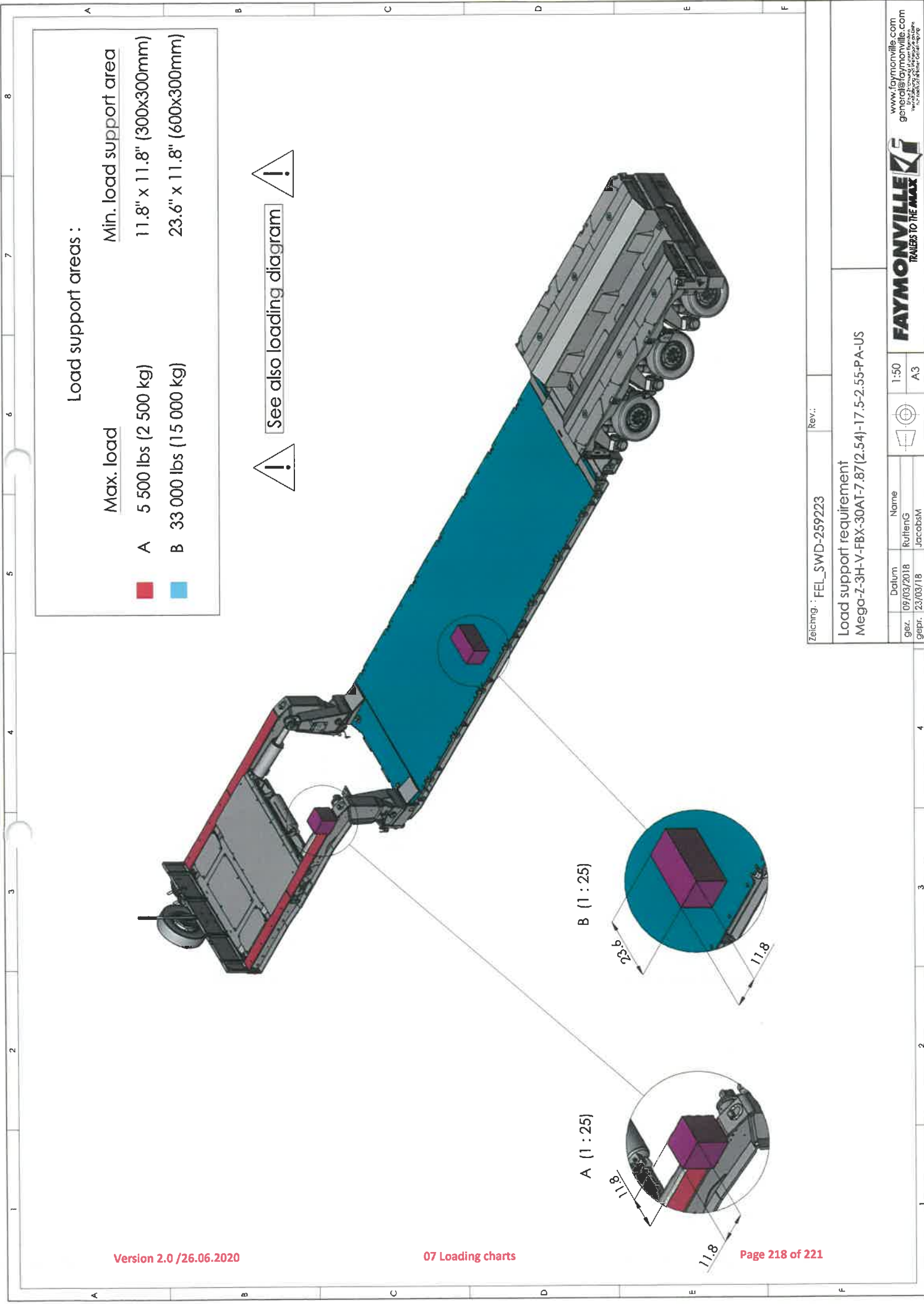

Load support areas :

	Max. load	Min. load support area
A	5 500 lbs (2 500 kg)	11.8" x 11.8" (300x300mm)
B	33 000 lbs (15 000 kg)	23.6" x 11.8" (600x300mm)

! See also loading diagram !

Zeichnung : FEL\_SWD-259223 Rev.:

Load support requirement  
 Mega-Z-3H-V-FBX-30AT-7.87(2.54)-17.5-2.55-PA-US

Gez.	Datum	Name	Scale
gepr.	09/03/2018	RuffenG	1:50
	23/03/18	Jacobsm	A3



payload on 2 supports (symetric)

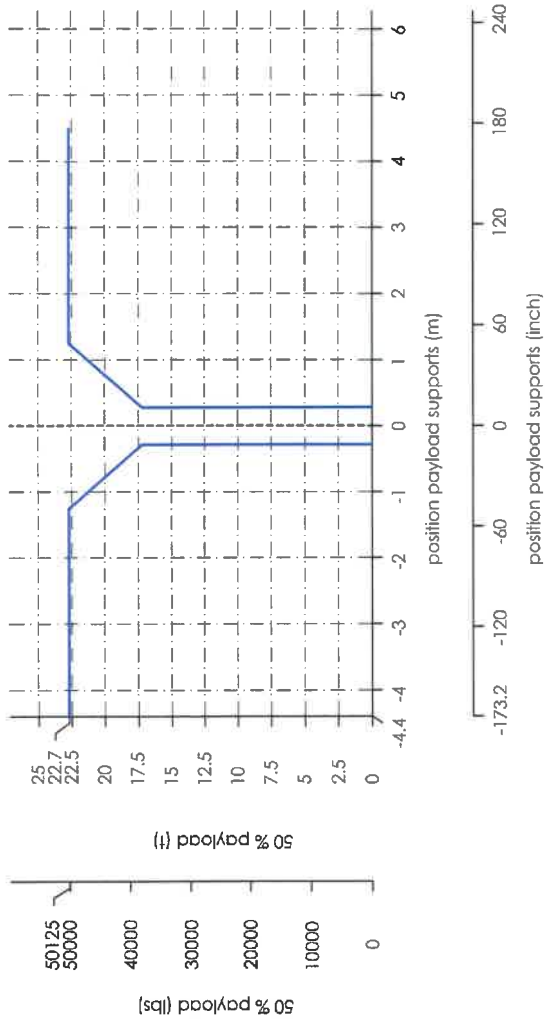

C.O.G.

(max. theoretical payload: 100250 lbs)

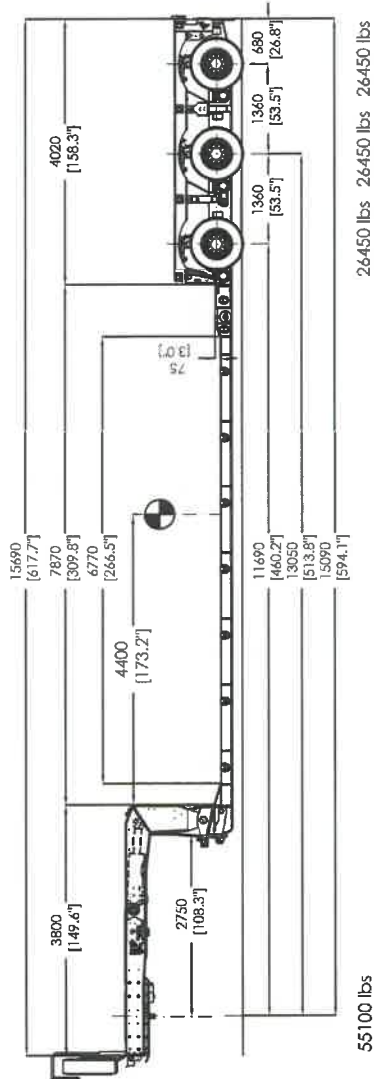

Zeichnung: WWP\_IBF-009567(1) Rev: 1:75 A3

Datum	Name
02/03/2018	LHE
07/03/2018	FAY

**Load Chart**  
 Mega-Z-3H-V-FBX-30/34AT-7.87(2.54)-17.5-2.55-PA-US  
 Faymonville Distribution AG  
 Duarreisraos 8  
 L-9990 Weiswampach  
 Tel.: +352 / 26 90 04 155  
 Fax.: +352 / 26 90 04 425  
 E-Mail: general@faymonville.com  
 Web: www.faymonville.com



Caution : the load chart does not take the deflection of the lowbed into account.  
 The deflection of the lowbed has a direct impact on the ground clearance and on the axle compensation.



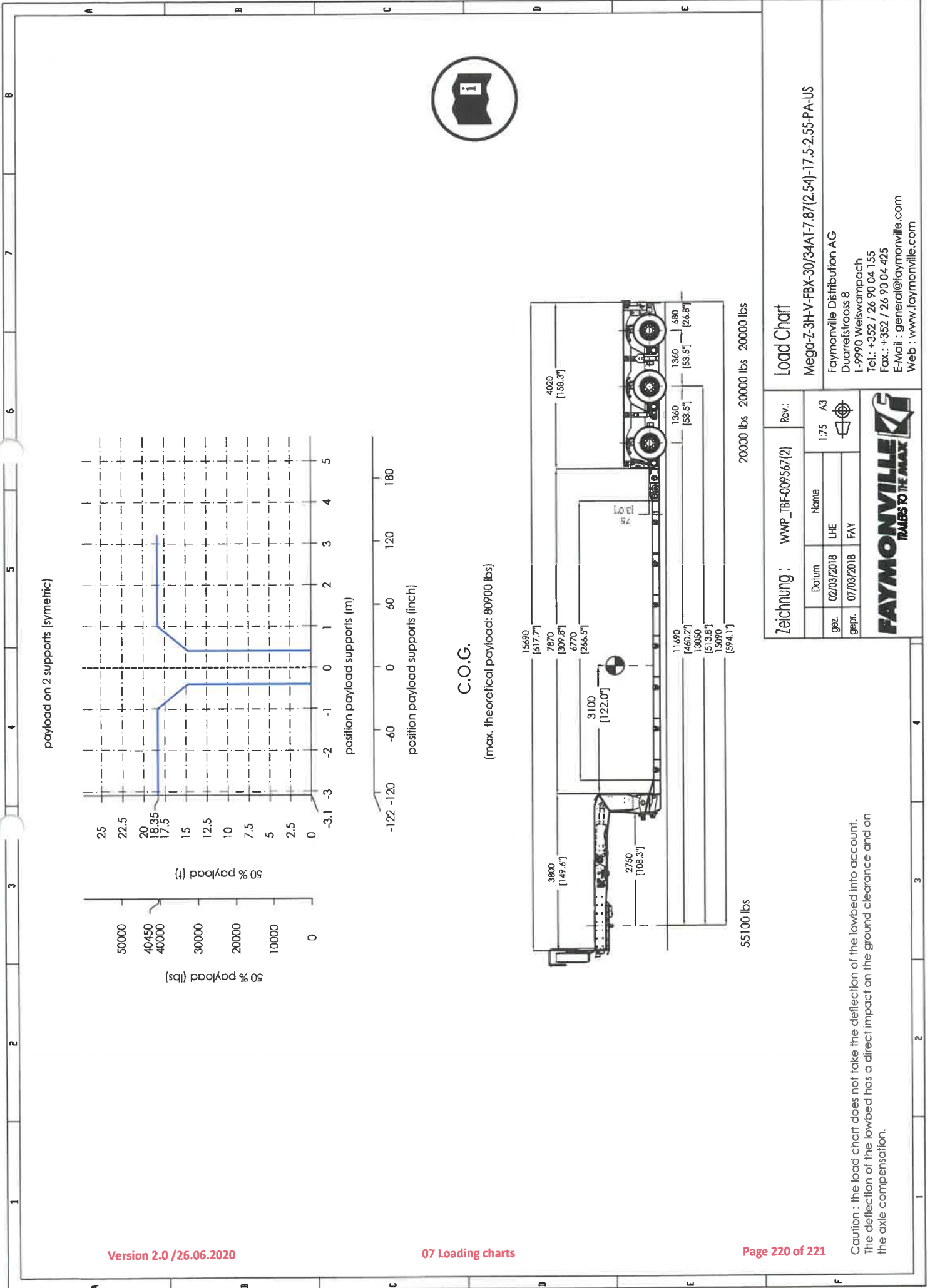

Zeichnung: WWP\_TBF-009567/2 Rev.: A3

Datum	Name	1:75	A3
02/03/2018	LHE		
07/03/2018	FAY		

**Load Chart**  
 Mega-Z-3H-V-FBX-30/34AT-7.87[2.54]-17.5-2.55-PA-US  
 Faymonville Distribution AG  
 Duarretstroos 8  
 L-9990 Weiswampach  
 Tel.: +352 / 26 90 04 155  
 Fax.: +352 / 26 90 04 425  
 E-Mail : general@faymonville.com  
 Web : www.faymonville.com



Caution : the load chart does not take the deflection of the lowbed into account.  
 The deflection of the lowbed has a direct impact on the ground clearance and on the axle compensation.

payload on 2 supports (symetric)

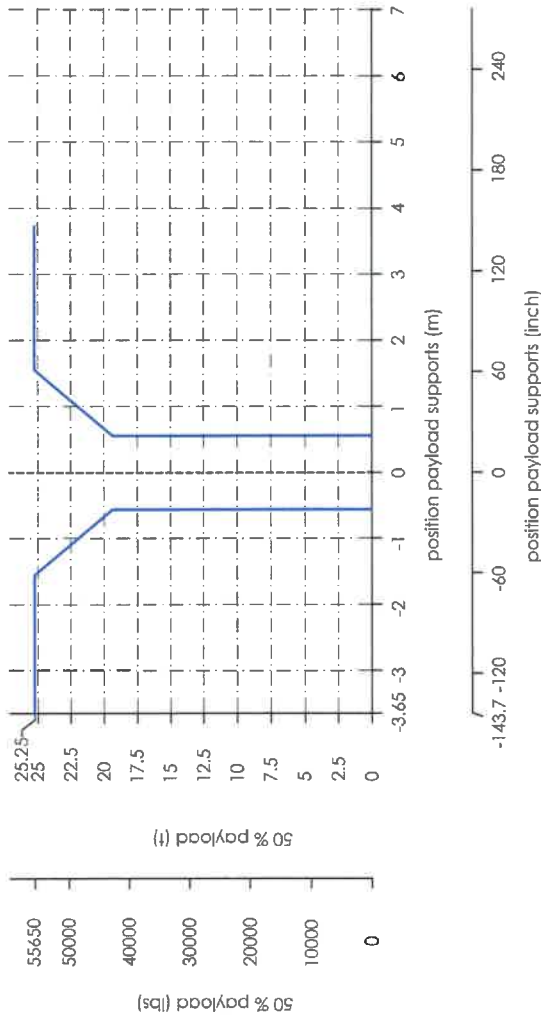

C.O.G.

(max. theoretical payload: 111300 lbs)

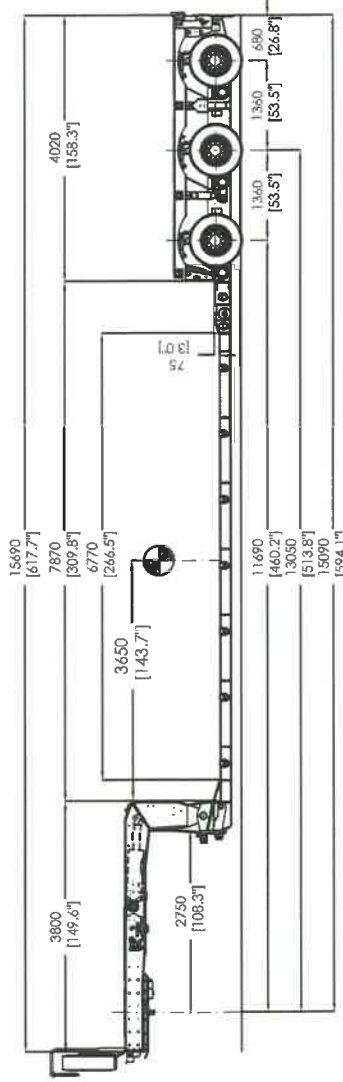

Zeichnung : WWP\_IBF-009567(3)

Rev.:

Datum	Name	1:75	A3
gez. 02/03/2018	LHE		
gepr. 07/03/2018	FAY		

Load Chart

Mega-Z-3H-V-FBX-30/34AT-7.87(2.54)-17.5-2.55-PA-US

Faymonville Distribution AG  
 Duarretrooss 8  
 L-9990 Weiswampach  
 Tel.: +352 / 26 90 04 155  
 Fax.: +352 / 26 90 04 425  
 E-Mail : general@faymonville.com  
 Web : www.faymonville.com



Caution : the load chart does not take the deflection of the lowbed into account.  
 The deflection of the lowbed has a direct impact on the ground clearance and on the axle compensation.